

USER MANUAL



Solar Hybrid Inverter

HEBP4880U200-Pro

HEBP48100U200-Pro

HEBP48120U200-Pro

Content

1. Safety	4
1.1 How to use this manual	4
1.2 Symbols in this manual	4
1.3 Safety instruction	4
2. Production Instructions	5
2.1 Instructions	5
2.2 Features	5
2.3 System connection diagram	6
2.4 Production Overview	7
2.5 Dimension drawing	8
3. Installation	9
3.1 Select the mount location	9
3.2 Pack list	10
3.3 Mount the inverter	12
3.4 Remove the terminal cover & anti insect net	13
4. Connection	14
4.1 Split-phase mode	14
4.2 Cable & circuit breaker requirement	14
4.3 GRID & LOAD & GEN connection	17
4.4 Battery Connection	18
4.5 PV connection	19
4.6 Dry contact connection	20
4.7 Grounding connection	20
4.8 Final assembly	21
4.9 Start up the inverter	21
4.9.1 Introduction	21
4.9.2 Precautions for connecting the parallel connecting lines	21
5. Operating Instructions	29
5.1 Operation interface	29
5.2 Parameter setting	34
5.3 Recommended Settings	46
5.4 Battery parameter	49
6. Communication	51
6.1 Overview	51
6.2 USB-B port	51
6.3 WIFI	52
6.4 RS485 port	53





6.5 CAN port.....	53
6.6 External CT port.....	54
6.7 Dry contact.....	55
7. Fault and Remedy.....	56
7.1 Fault code.....	56
7.2 Troubleshooting.....	59
8. Protection and Maintenance.....	61
8.1 Protection features.....	61
8.2 Maintenance.....	63
9. Datasheet.....	64

1. Safety

1.1 How to use this manual

- This manual contains important information, guidelines, operation and maintenance for the following products
HEBP Series : 4880U200-Pro, 48100U200-Pro, 48120U200-Pro
- The manual must be followed during installation and maintenance

1.2 Symbols in this manual

Symbol	Description
 DANGER	DANGER indicates a hazardous situations which if not avoided will result in death or serious injury.
 WARNING	WARNING indicates a hazardous situations which if not avoided could result in death or serious injury.
 CAUTION	CAUTION indicates a hazardous situations which if not avoided could result in minor or moderate injury.
 NOTICE	NOTICE provide some tips on operation of products.

1.3 Safety instruction

 **DANGER**

- This chapter contains important safety instructions. Read and keep this manual for future reference.
- Be sure to comply the local requirements and regulation to install this inverter.
- Beware of high voltage. Please turn off the switch of each power sources before and during the installation to avoid electric shock.
- For optimum operation of this inverter, please follow required specification to select appropriate cable size and necessary protective device.
- Do not connect or disconnect any connections when the inverter is working.
- Do not open the terminal cover when the inverter working.
- Make sure the inverter is well grounding.
- Never cause AC output and DC input short circuited.
- Do not disassembly this unit, for all repair and maintenance, please take it to the professional service center.
- Never charge a frozen battery.

2. Production Instructions

2.1 Instructions

HEBP series is a new type of solar energy storage inverter control inverter integrating solar energy storage & utility charging and energy storage, AC sine wave output. It adopts DSP control and features high response speed, reliability, and industrial standard through an advanced control algorithm.

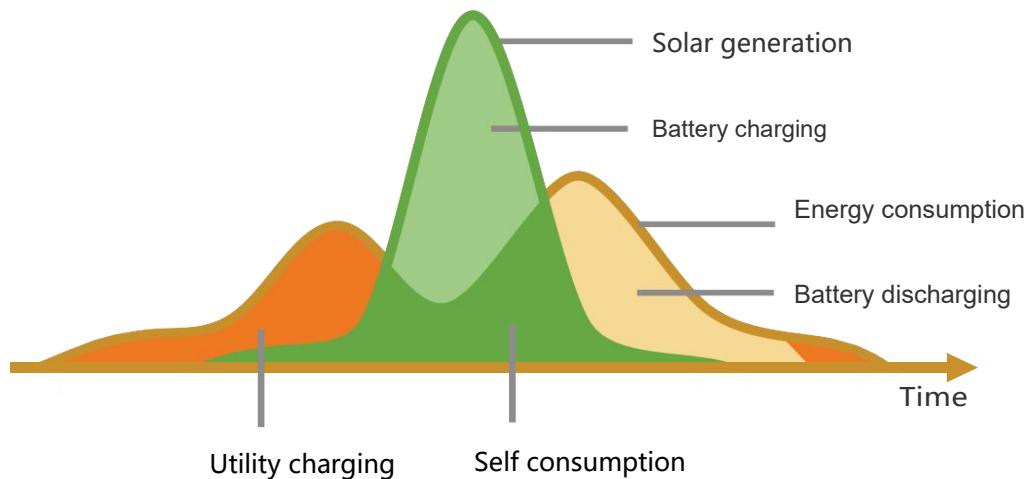

2.2 Features

- Supports lead acid battery and li-ion battery connections.
- With a dual activation function when the li-ion battery is dormant; either mains/photovoltaic power supply access can trigger the activation of the li-ion battery.
- Support single-phase pure sine wave output.
- Supports four different voltage levels of 100\105\110\115\120\127Vac per phase.
- Supports two solar inputs and simultaneous tracking of two solar maximum power charging/carrying capacity functions.
- Dual MPPT with 99.9% efficiency and maximum 32A current in a single circuit, perfectly adapted to high power modules.
- 2 charging modes are available: solar only, grid/solar hybrid charging.
- With the time-slot charging and discharging setting function, you can set the time period for cutting in/out of mains charging and switch the time period between battery discharging and mains bypass power supply mode.
- Energy saving mode function to reduce no-load energy losses.
- With two output modes of utility bypass and inverter output, with uninterrupted power supply function.
- LCD large screen dynamic flow diagram design, easy to understand the system data and operation status.
- 360° protection with complete short circuit protection, over current protection, over under voltage protection, overload protection, backfill protection, etc.
- Support CAN, USB, and RS485 communication.

2.3 System connection diagram

The diagram below shows the system application scenario of this product. A complete system consists of the following components:

- **PV modules:** converts light energy into DC energy, which can be used to charge the battery via an inverter or directly inverted into AC power to supply the load.
- **Utility grid or generator:** connected to the AC input, it can supply the load and charge the battery at the same time. The system can also operate generally without the mains or generator when the battery and the PV module power the load.
- **Battery:** The role of the battery is to ensure the regular power supply of the system load when the solar energy is insufficient and there is no mains power.
- **Home load:** Various household and office loads can be connected, including refrigerators, lamps, televisions, fans, air conditioners, and other AC loads.
- **Inverter:** The energy conversion device of the whole system.

The actual application scenario determines the specific system wiring method

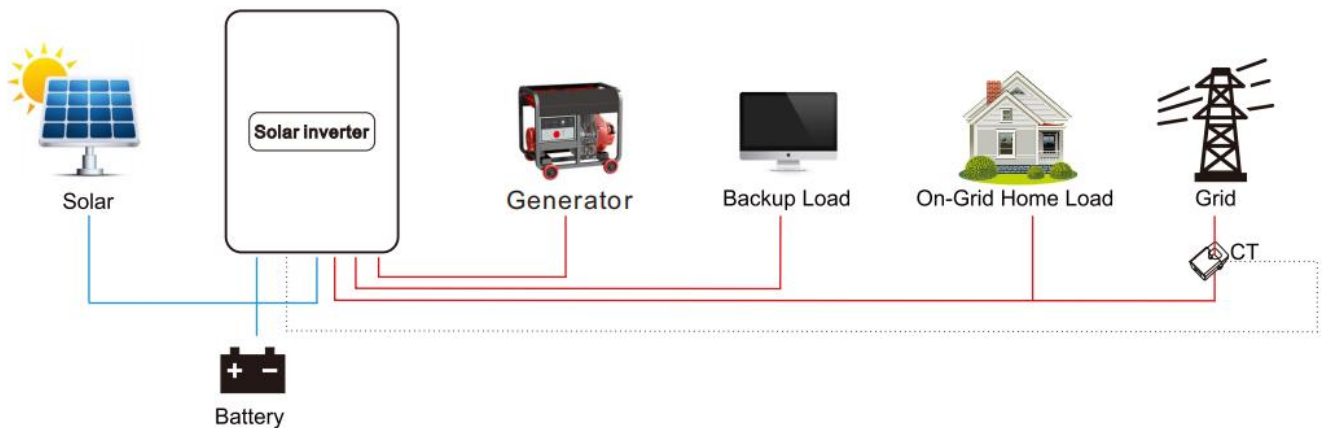

2.4 Production Overview

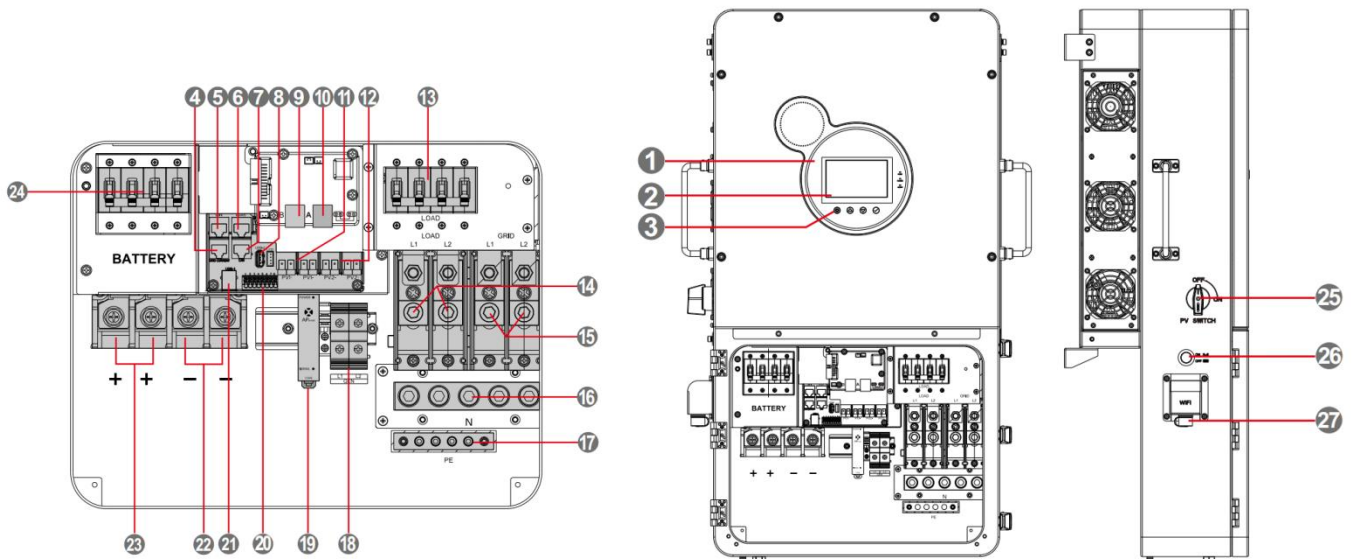

1	LED Indicators	15	Grid terminals (L1+L2)
2	LCD screen	16	Neutral Busbar
3	Key	17	Grounding I Busbar
4	External CT port	18	Generator input terminal (L1+L2)
5	WIFI port 1	19	RSD
6	BMS RS485 port	20	Dry contact
7	BMS CAN port	21	USB-A port
8	USB-B port	22	Battery negative
9	Parallel port B	23	Battery positive
10	Parallel port A	24	Battery Circuit Breaker
11	PV1 terminals	25	PV switch
12	PV2 terminals	26	ON/OFF switch
13	Load Breaker	27	WIFI port 2
14	Load terminals (L1+L2)		

2.5 Dimension drawing

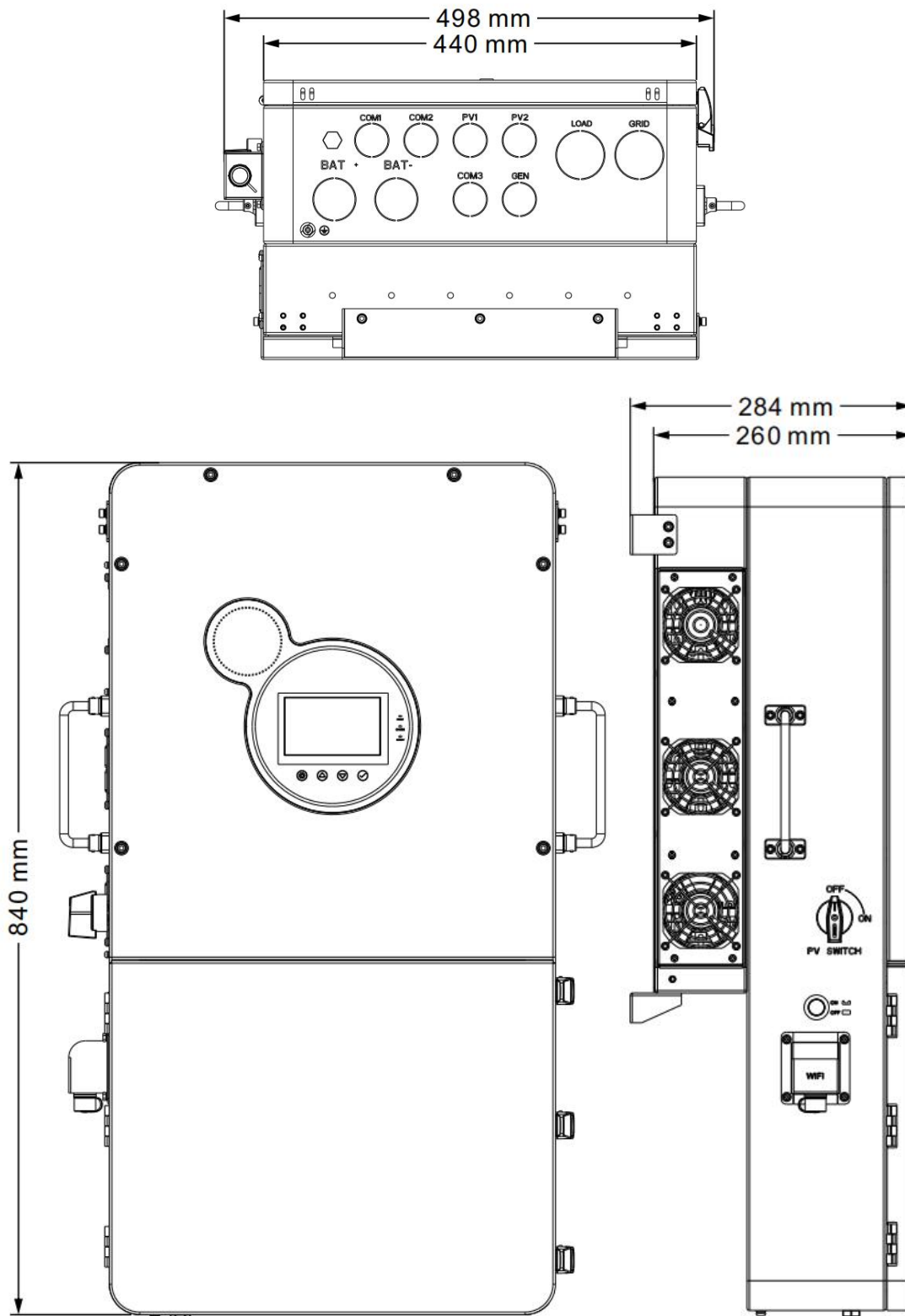

3. Installation

3.1 Select the mount location

HEBP series can be used outdoors (protection class IP65). Please consider the followings before selecting the location:

- Choose the solid wall to install the inverter
- Mount the inverter at eye level
- Adequate heat dissipation space must be provided for the inverter
- Installation location is a cool and ventilated place, under the photovoltaic panels or under the eaves, do not direct sunlight exposure
- The ambient temperature should be between $-25\sim 60^{\circ}\text{C}$ ($-13\sim 140^{\circ}\text{F}$) to ensure optimal operation

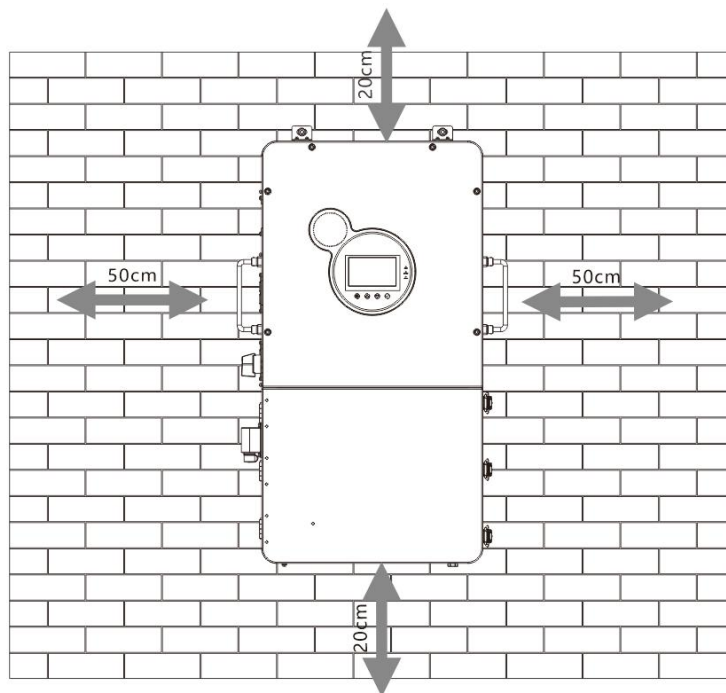



DANGER



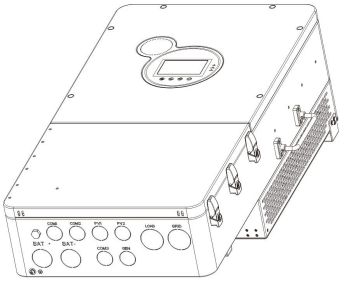
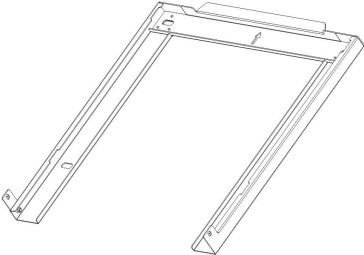
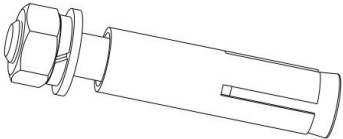

- Do not install the inverter near flammable materials
- Do not install the inverter in potentially explosive areas
- Do not install the inverter and lead-acid batteries in enclosed spaces."

CAUTION

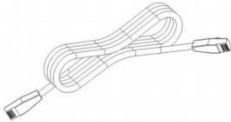
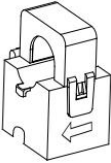
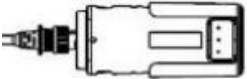
- Do not install the inverter in direct sunlight.

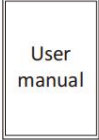
3.2 Pack list

NO	Picture	Description	Quantity
1		inverter	1pcs
2		Wallhanger	2pcs
3		M8*60 Expansion bolts used to Secure the wall-mount bracket To the wall	4pcs
4		4mmHex head screwdriver	1pcs
5		Parallel communication cable	1pcs
6		CT	2pcs
7		WIFI logger	1pcs

8		User manual	1pcs
9		The warranty card	1pcs
10		Quality Certificate	1pcs
11		Outgoing inspection report	1pcs

3.3 Mount the inverter

Step1:Determine the positions for drilling holes,ensure the position of holes are level,then mark them with a marker pen,use the hammer drill to drill holes on the wall.Keep the hammer drill perpendicular to the wall,do not shake when drilling, so as not to damage the wall.If the error of the hole is too big,you need to reposition.

Step2: Insert M8*60 expansion bolt vertically into the hole and pay attention to the insertion depth of the expanding bolt(should be deep enough)

Step3:Align the wall hanger with the position of holes,fix the wall hanger on the wall by tightening the expansion bolt with nuts.

Step4:Hang the inverter on the wall hanger first,and then fix the inverter and the wall hanger with M6 hexagon socket screws.

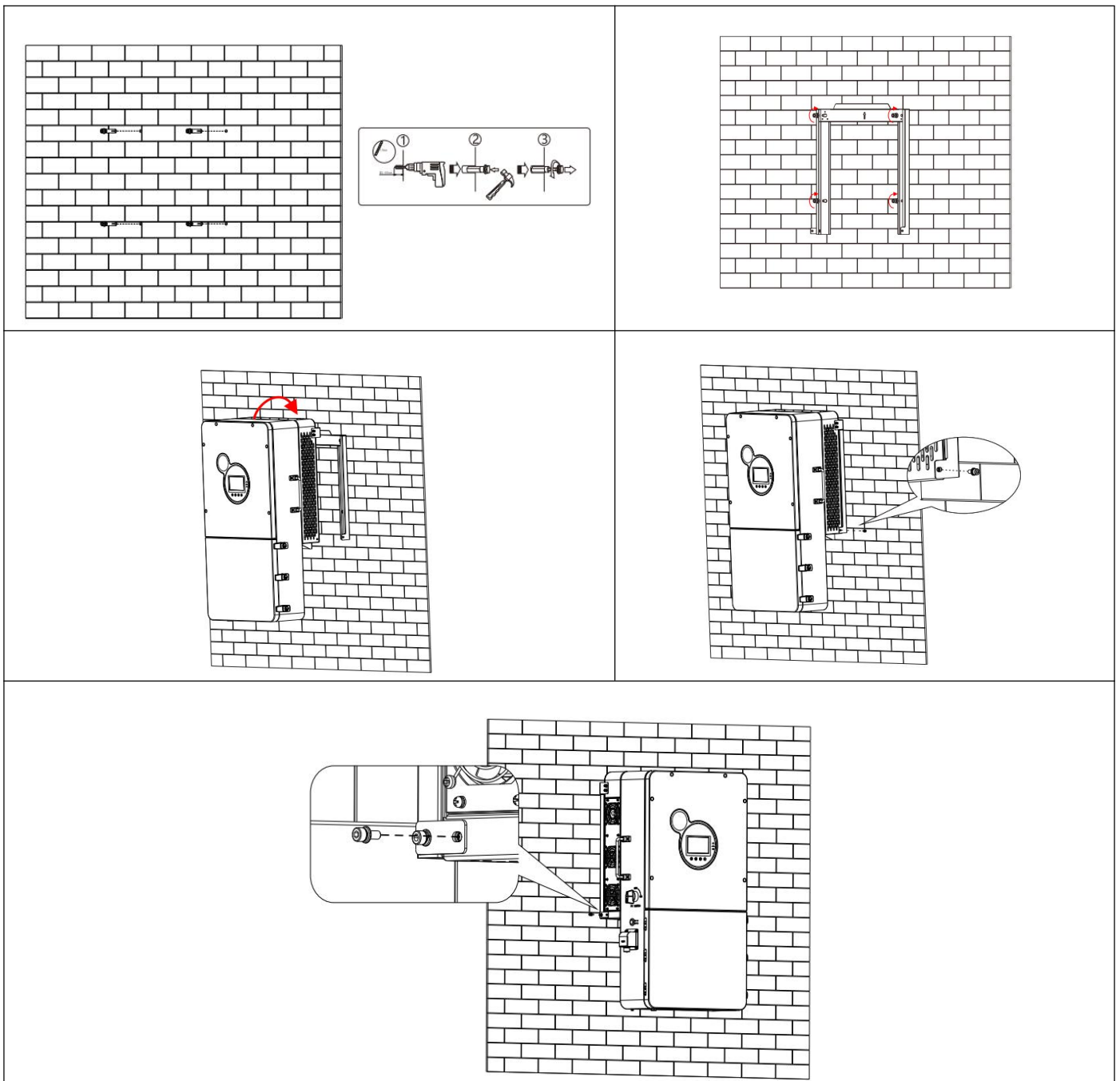

3.4 Remove the terminal cover & anti insect net

Using a screwdriver, remove the fan shroud and open the cover.

Removable fan cover
for cleaning

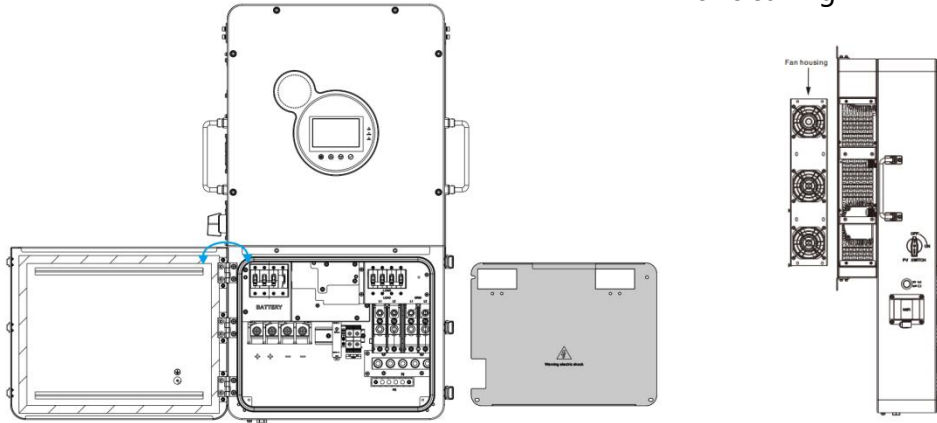

ⓘ NOTICE

- When using the device in areas with poor air quality, the fan cover is easily blocked by air particles, please disassemble and clean the fan regularly to avoid affecting the inverter's internal air flow rate, which may trigger the device over-temperature protection fault (19/20 faults) affecting the power supply and the service life of the inverter.

4. Connection

4.1 Split-phase mode

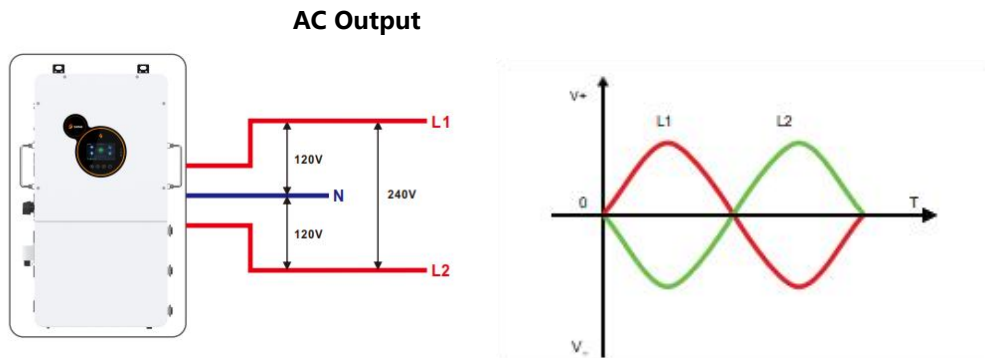

Items	Description
Applicable Model	HEBP series U model
AC Output Phase Voltage (L-N)	100~120Vac, 120Vac (default)
AC Output Line Voltage (L1-L2)	200~240Vac, 240Vac (default)

4.2 Cable & circuit breaker requirement



● PV INPUT

Model	No. of PV	Cable Diameter	Max. PV Input Current	Circuit Breaker Spec
HEBP4880U200-Pro	PV1	6mm ² / 10 AWG	25A	2P-25A
	PV2	6mm ² / 10 AWG	25A	2P-25A
HEBP48100U200-Pro	PV1	6mm ² / 10 AWG	25A	2P-25A
	PV2	6mm ² / 10 AWG	25A	2P-25A
HEBP48120U200-Pro	PV1	6mm ² / 10 AWG	25A	2P-25A
	PV2	6mm ² / 10 AWG	25A	2P-25A



● BATTERY

Model	Cable Diameter	Max. Battery Current	Circuit Breaker Spec
HEBP4880U200-Pro	34mm ² / 2 AWG	200A	2P-250A
HEBP48100U200-Pro	42mm ² / 1 AWG	230A	2P-250A
HEBP48120U200-Pro	54mm ² / 0 AWG	270A	2P-300A



● AC INPUT

Model	Schema	Cable Diameter	Circuit Breaker Spec
HEBP4880U200-Pro		13mm ² /6AWG (L1/L2/N)	3P-63A
HEBP48100U200-Pro		13mm ² /6AWG (L1/L2/N)	3P-63A
HEBP48120U200-Pro		13mm ² /6AWG (L1/L2/N)	3P-63A

● GENERATOR INPUT

Model	Schema	Cable Diameter	Circuit Breaker Spec
HEBP4880U200-Pro		13mm ² /6AWG (L1/L2/N)	3P-63A
HEBP48100U200-Pro		13mm ² /6AWG (L1/L2/N)	3P-63A
HEBP48120U200-Pro		13mm ² /6AWG (L1/L2/N)	3P-63A

● AC OUTPUT

Model	Schema	Cable Diameter	Circuit Breaker Spec
HEBP4880U200-Pro		13mm ² /6AWG (L1/L2/N)	3P-63A
HEBP48100U200-Pro		13mm ² /6AWG (L1/L2/N)	3P-63A
HEBP48120U200-Pro		13mm ² /6AWG (L1/L2/N)	3P-63A

ⓘ NOTICE

- **PV Input, AC Input, AC Output, Generator Input**

1. Use a stripper to remove the 6~8mm insulation of the cable
2. Fixing a ferrule at the end of the cable. (ferrule needs to be prepared by the user)

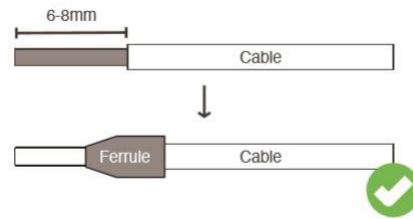

- **BATTERY**

1. Use a stripper to remove the 6~8mm insulation of the cable
2. Fixing cable lugs that supply with the box at the end of the cable.

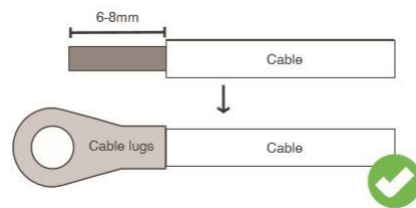

The wire diameter is for reference only. If the distance between the PV array and the inverter or between the inverter and the battery is long, using a thicker wire will reduce the voltage drop and improve the performance of the system.

4.3 GRID & LOAD & GEN connection

Connect the live, neutral and ground wires according to the cables' position and order shown in the diagram below.

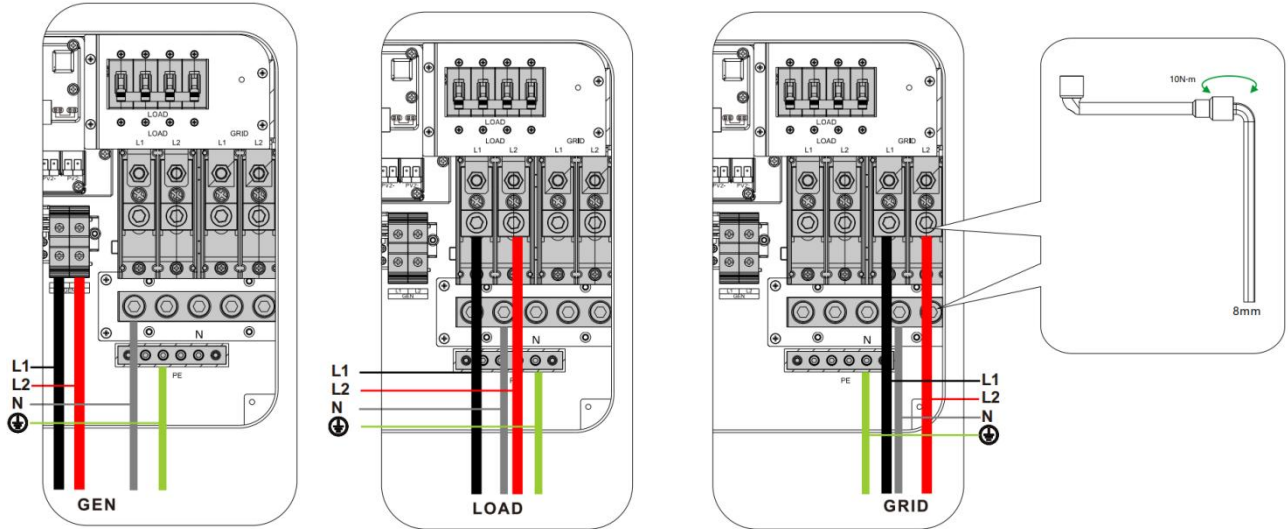

⚠ DANGER

- Before connecting AC inputs and outputs, the circuit breaker must be opened to avoid the risk of electric shock and must not be operated with electricity.
- Please check that the cable used is sufficient for the requirements, too thin, poor quality cables are a serious safety hazard.

4.4 Battery Connection

Connect the positive and negative cable of the battery according to the diagram below

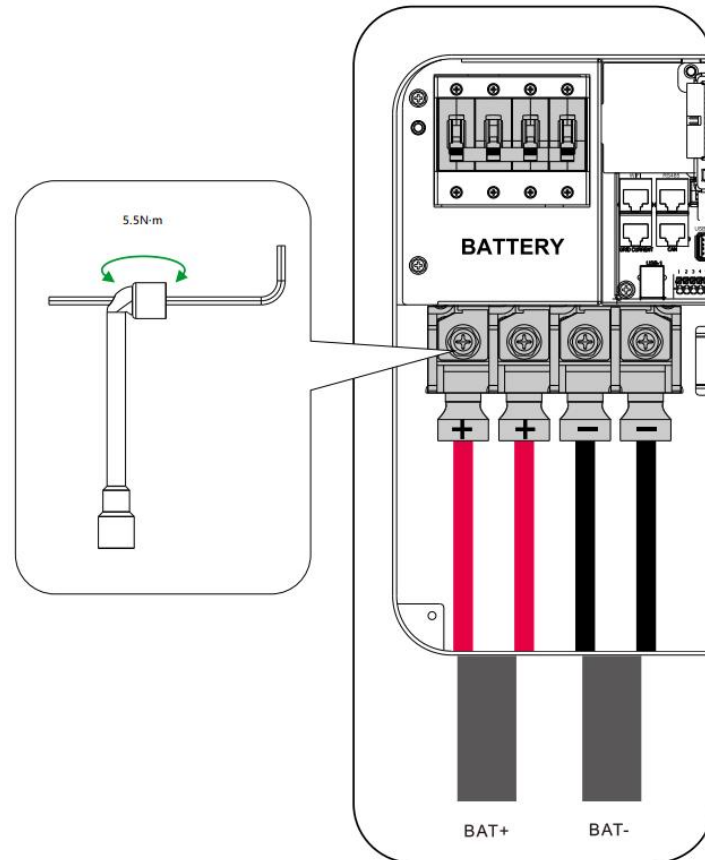

DANGER

- Before connecting battery, the circuit breaker must be opened to avoid the risk of electric shock and must not be operated with electricity.
- Make sure that the positive and negative terminals of the battery are connected correctly and not reversed, otherwise the inverter may be damaged.
- Please check that the cable used is sufficient for the requirements, too thin, poor quality.
- cables are a serious safety hazard.

4.5 PV connection

Connect the positive and negative wires of both PVs in the cable locations and sequence shown in the diagram below.

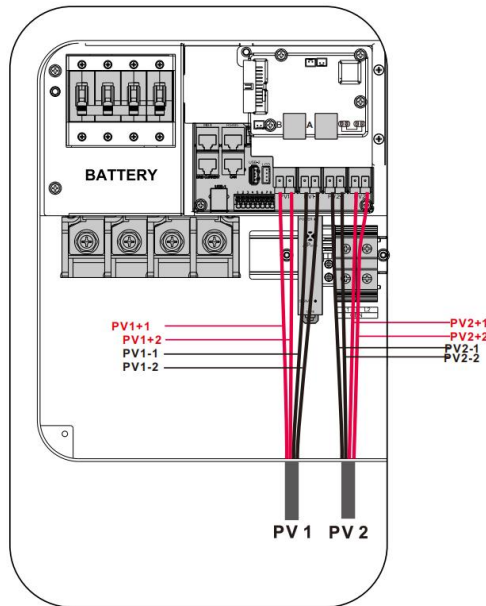

⚠ DANGER

- Before connecting the PV, the circuit breaker must be disconnected to avoid the risk of electric shock and must not be energized.
- Make sure that the open-circuit voltage of the PV modules connected in series does not exceed the maximum open-circuit voltage of the inverter (the value is 550V), otherwise the inverter may be damaged.

Transmitter-PLC Device

The APsmart Rapid Shutdown System Transmitter-PLC is part of a rapid shutdown solution when paired with APsmart RSD-D, a PV module rapid shutdown unit. powered on, the Transmitter-PLC sends a signal to the RSD-D units to keep their PV modules connected and supplying energy.

RSD-D units automatically enter rapid shutdown mode when the Transmitter-PLC is switched off and resume energy production when power is restored to the Transmitter-PLC

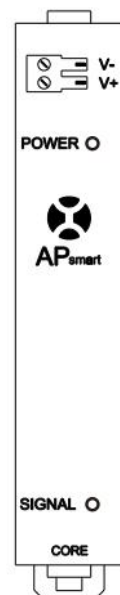

While

4.6 Dry contact connection

Use a small screwdriver to push back the direction indicated by the arrow, then insert the communication cable into the dry junction port. (Communication cable diameter 0.2~1.5mm²)

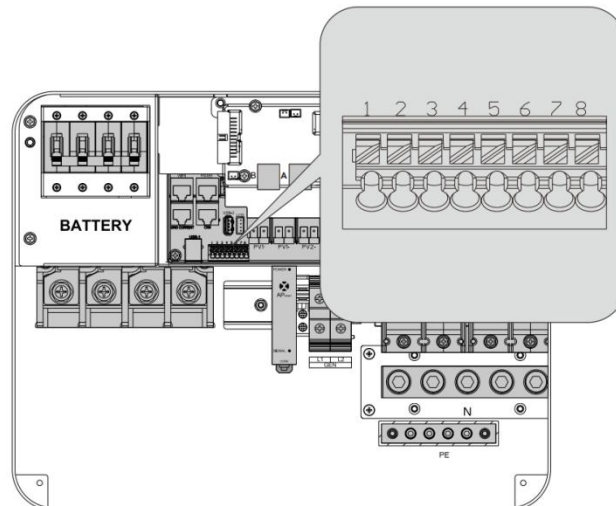

4.7 Grounding connection

Please make sure the grounding terminal connect to the Grounding Bar.

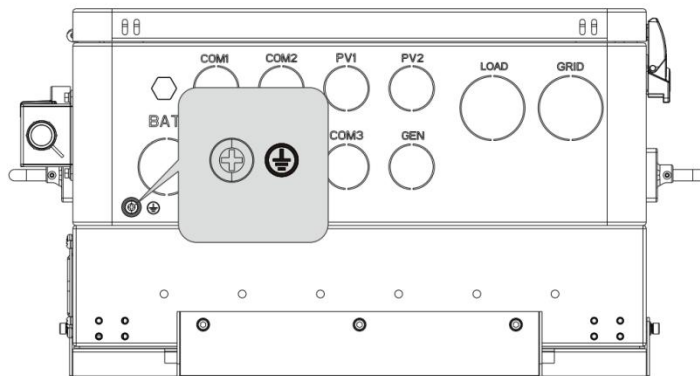

NOTICE

- The grounding cable should have a diameter of not less than 4 mm² and be as close as possible to the grounding point.

4.8 Final assembly

After ensuring that the wiring is reliable and the wire sequence is correct, install the terminal protection cover in place.

- **Step 1** : Close the circuit breaker of the battery.
- **Step 2** : Press the rocker switch on the bottom of inverter, the screen and indicators light up to indicate that the inverter has been activated.
- **Step 3** : Sequential close of the circuit breakers for PV, AC input and AC output.
- **Step 4** : Start the loads one by one in order of power from small to large

4.9 Start up the inverter

4.9.1 Introduction

1. Up to six units connected in parallel.
2. When using the parallel operation function, the following connecting lines (package accessories) shall be firmly and reliably connected:

Parallel communication line*1

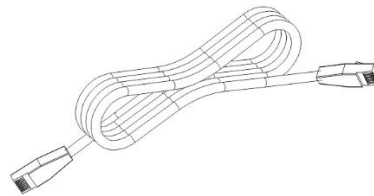

4.9.2 Precautions for connecting the parallel connecting lines

Warning 

1. PV connection:

When connected in parallel, the PV arrays of each machine must be independent and the PV arrays of PV1 and PV2 of each machine must also be independent.

2. Battery wiring:

Parallel connection in single or three-phase: ensure that all solar storage inverters are connected to the same battery, with BAT + connected to BAT + , BAT - connected to BAT - , and that the connection is correct with the same wiring length and line diameter before power on, so as to avoid the abnormal operation of parallel system output caused by wrong connection.

3. LOAD wiring:

When connecting the parallel machine, all the inverse control integrated machine must be connected to L and L, N and N line connected, PE and PE connected, and ensure that the power on and off before connecting correctly and the wiring length and wire diameter is the same, to avoid connecting incorrectly caused by the output of the parallel system does not work properly.

When connecting three-phase parallel machines, all inverse control integrated machines must be connected N to N wire and PE to PE. The L lines of all machines in the same phase need to be connected together, but the L lines of AC outputs of different phases cannot be connected together. Other precautions are the same as single-phase connection of parallel machines.

4.GRID wiring:

Parallel connection in single phase: ensure L-to-L, N-to-N and PE-to-PE connection for all solar storage inverters, and that the connection is correct with the same wiring length and line diameter before power on, so as to avoid the abnormal operation of parallel system output caused by wrong connection. Meanwhile, it is not allowed to have multiple different AC source inputs to avoid damage to the external equipment of the inverter. The consistency and uniqueness of AC source input shall be ensured.

Parallel connection in three-phase: ensure N-to-N and PE-to-PE connection for all solar storage inverters. The L lines of all inverters connected to the same phase need to be connected together. But L lines of different phases cannot be joined together. Other connection precautions are the same as parallel connection in single phase.

5.Wiring of parallel communication line:

Our parallel communication cable is a shielded 10Pin network connection cable, which can be used for single-phase or three-phase parallel connection. Each machine must be connected with one out and one in. This means that the machine "Parallel_A" is connected to the machine to be parallelized "Parallel_B", and that the machine "Parallel_A" is not allowed to connect to the "Parallel_B". "Parallel_B" or "Parallel_A" is connected to the machine to be parallelized "Parallel_A". At the same time, the parallel communication cable of each machine should be fastened with 10Pin network connection cable to avoid disconnection or poor contact of the parallel communication cable, which may cause abnormal operation or damage to the system output.

6.Before and after connecting the system, please check the following system wiring diagrams in detail to ensure that all wiring is correct and reliable before powering on.

7. After the system is wired, powered on and in normal operation, if a new inverter needs to be connected, make sure to disconnect the battery input, PV input, AC input and AC output, and that all solar storage inverters are powered off before reconnecting into the system

4.9.3 Split-phase parallel connection

Setting for each inverter: Select "Parallel" for parallel mode, select "Split Phase" for grid type, when "120V" is selected for output phase voltage, the output L1-L2 voltage is 240V, L1-N voltage is 120V, L2-N voltage is 120V.

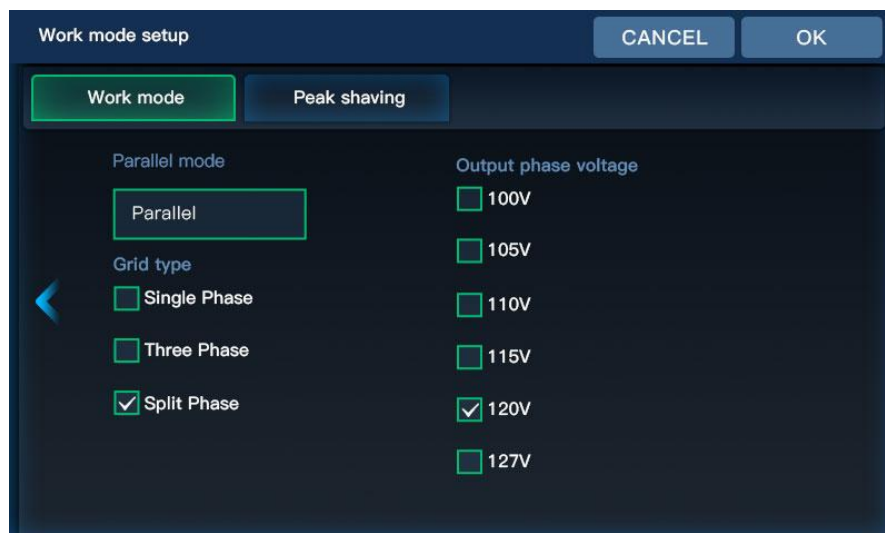

The wiring diagram is shown below:

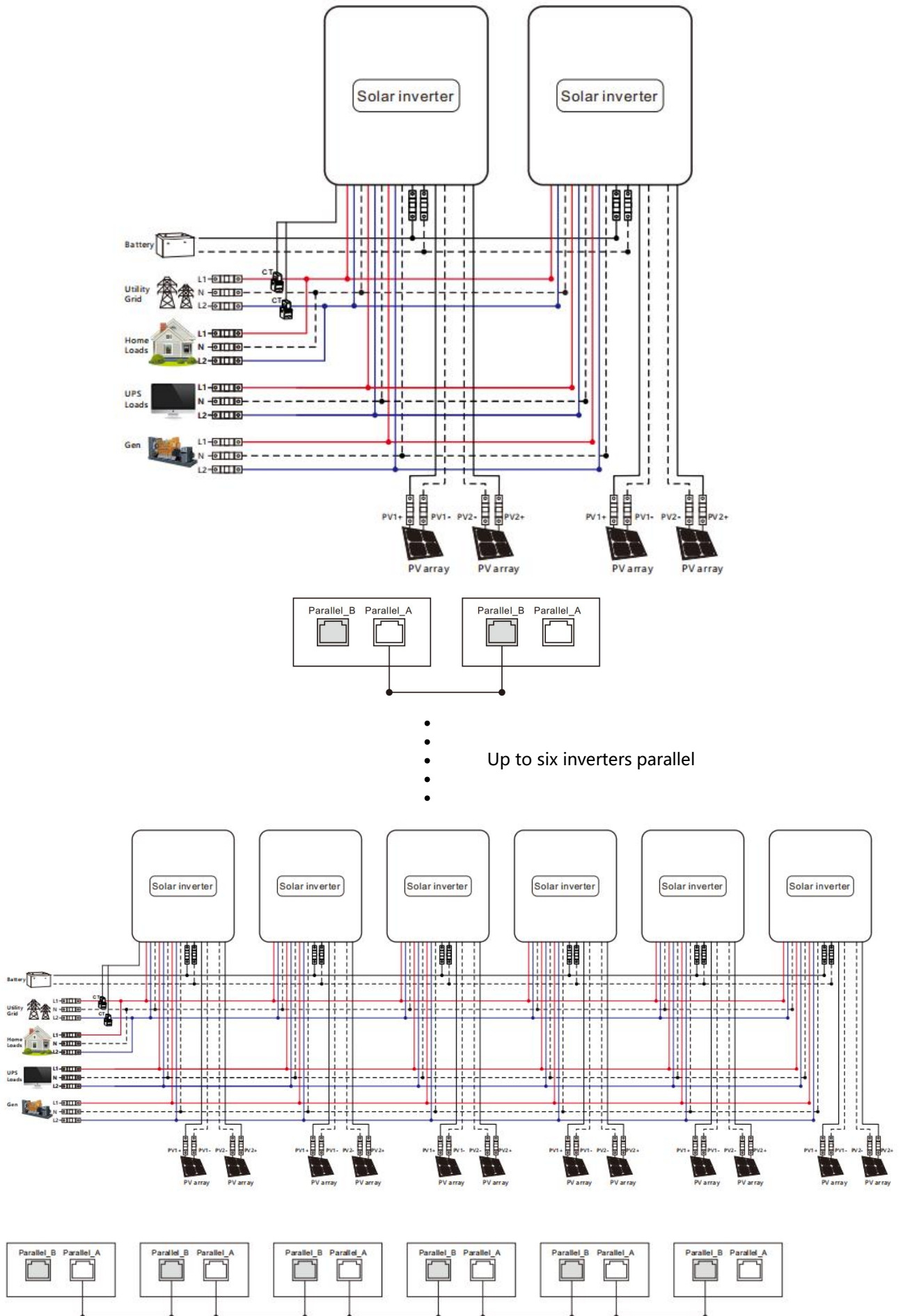

4.9.4 Three-phase parallel connection

(1) 2 inverters connected in parallel to form a three-phase output (three-phase unbalanced)

P1 machine setting: Parallel mode select "Three phase A", grid type select "Three Phase", when output phase voltage select "120V", the output L1-L2 voltage is 208V, L1-N voltage is 120V, L2-N voltage is 120V.



Work mode setup		CANCEL	OK
<div style="display: flex; justify-content: space-between;"> Work mode Peak shaving </div>			
Parallel mode	Output phase voltage		
<input checked="" type="checkbox"/> Three phase A	<input type="checkbox"/> 100V		
	<input type="checkbox"/> 105V		
Grid type	<input type="checkbox"/> 110V		
<input type="checkbox"/> Single Phase	<input type="checkbox"/> 115V		
<input checked="" type="checkbox"/> Three Phase	<input checked="" type="checkbox"/> 120V		
<input type="checkbox"/> Split Phase	<input type="checkbox"/> 127V		

P2 machine setting: Parallel mode select "Three phase B", grid type select "Three Phase", when the output phase voltage select "120V", then the output L1-L2 voltage is 208V, L1-N voltage is 120V, L2-N voltage is 120V.



Work mode setup		CANCEL	OK
<div style="display: flex; justify-content: space-between;"> Work mode Peak shaving </div>			
Parallel mode	Output phase voltage		
<input checked="" type="checkbox"/> Three phase B	<input type="checkbox"/> 100V		
	<input type="checkbox"/> 105V		
Grid type	<input type="checkbox"/> 110V		
<input type="checkbox"/> Single Phase	<input type="checkbox"/> 115V		
<input checked="" type="checkbox"/> Three Phase	<input checked="" type="checkbox"/> 120V		
<input type="checkbox"/> Split Phase	<input type="checkbox"/> 127V		

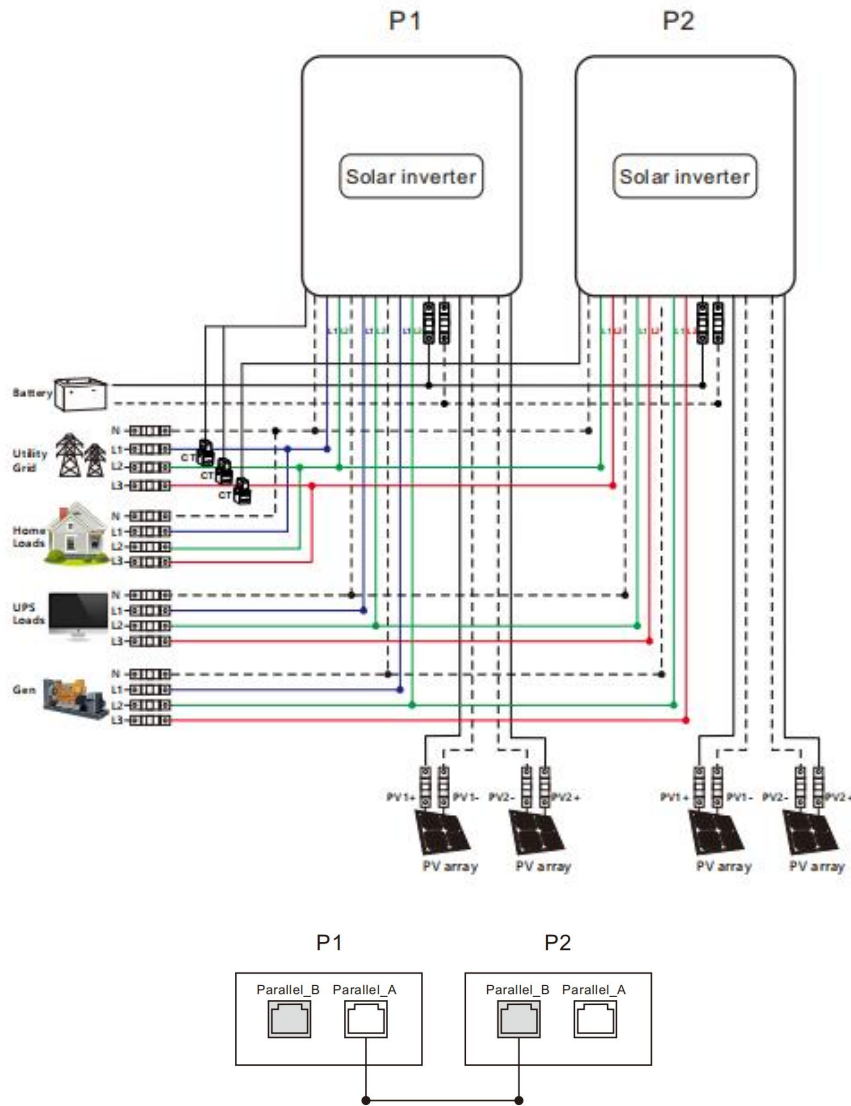

(2)3 or 6 inverters in parallel to form a three-phase output (three-phase balanced)

P1 machine setting: Parallel mode select "Three phase A", grid type select "Three Phase", when output phase voltage select "120V", the output L1-L2 voltage is 208V, L1-N voltage is 120V, L2-N voltage is 120V.

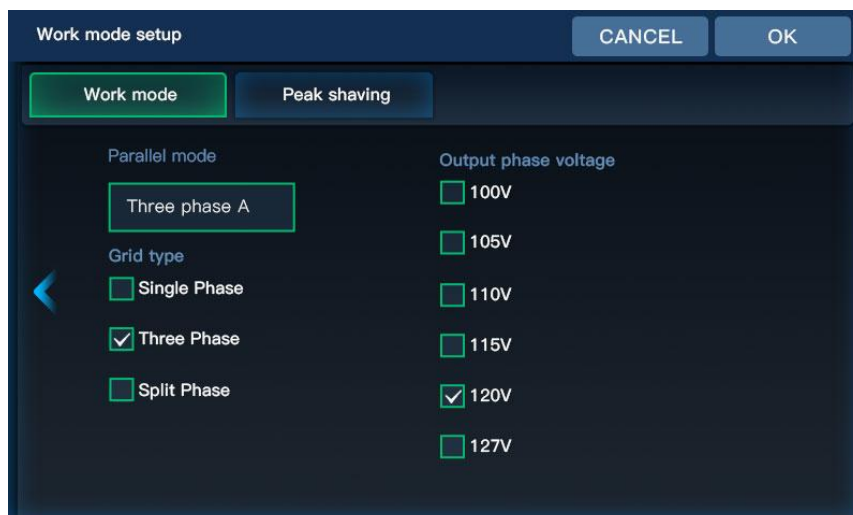

P2 machine setting: Parallel mode select "Three phase B", grid type select "Three Phase", when the output phase voltage select "120V", then the output L1-L2 voltage is 208V, L1-N voltage is 120V, L2-N voltage is 120V.



The screenshot shows the 'Work mode setup' dialog box with the following settings:

Section	Option	Selected
Parallel mode	Three phase B	Selected (highlighted)
	Three phase A	Not selected
	Three phase C	Not selected
Grid type	Single Phase	Not selected
	Three Phase	Selected (checked)
	Split Phase	Not selected
Output phase voltage	100V	Not selected
	105V	Not selected
	110V	Not selected
	115V	Not selected
	120V	Selected (checked)
127V	Not selected	

P3 machine setting: Parallel mode select "Three phase C", grid type select "Three Phase", when output phase voltage select "120V", then output L1-L2 voltage is 208V, L1-N voltage is 120V, L2-N voltage is 120V.



The screenshot shows the 'Work mode setup' dialog box with the following settings:

Section	Option	Selected
Parallel mode	Three phase C	Selected (highlighted)
	Three phase A	Not selected
	Three phase B	Not selected
Grid type	Single Phase	Not selected
	Three Phase	Selected (checked)
	Split Phase	Not selected
Output phase voltage	100V	Not selected
	105V	Not selected
	110V	Not selected
	115V	Not selected
	120V	Selected (checked)
127V	Not selected	

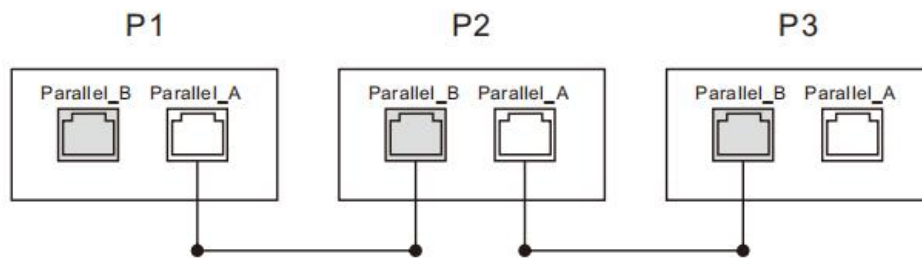
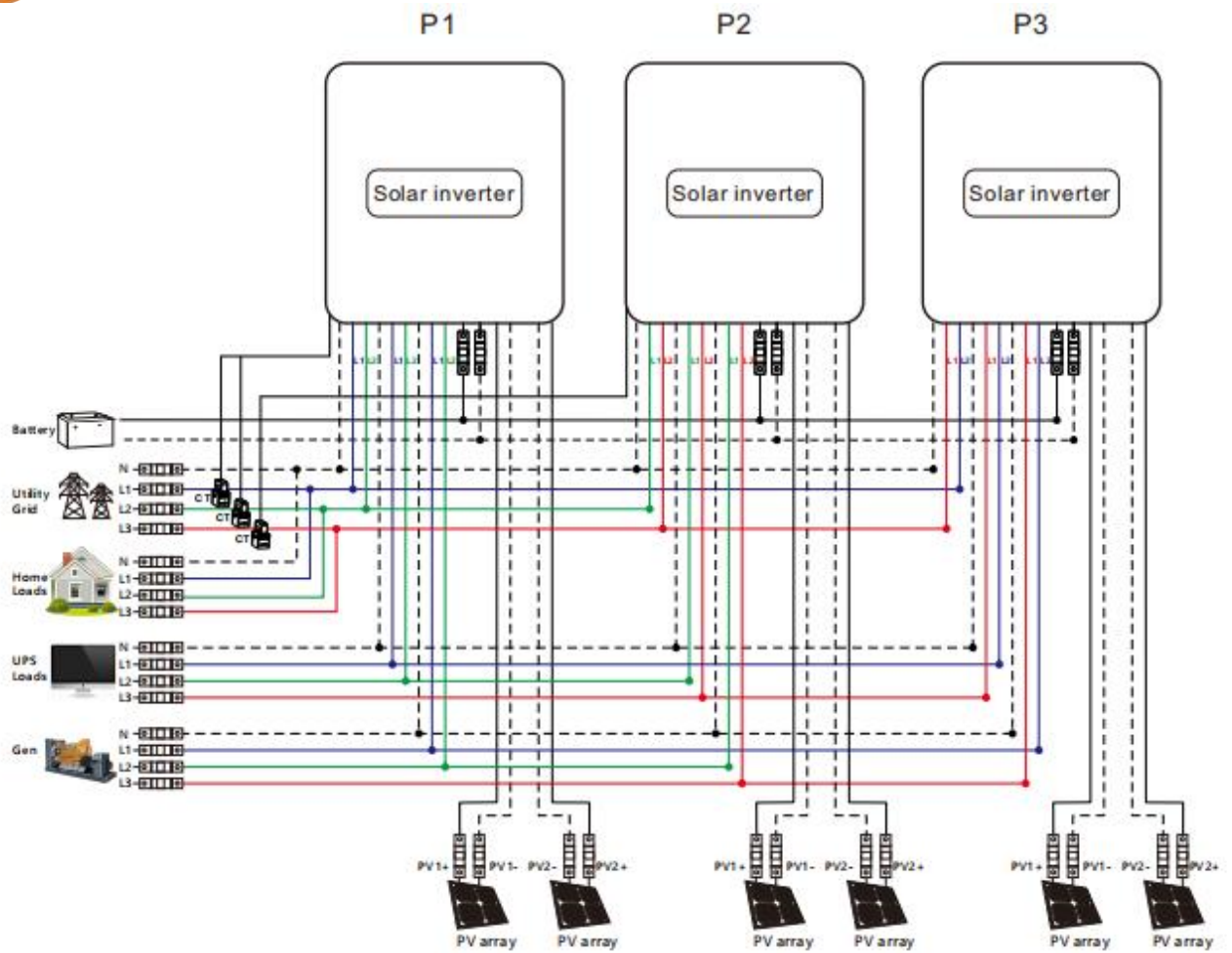





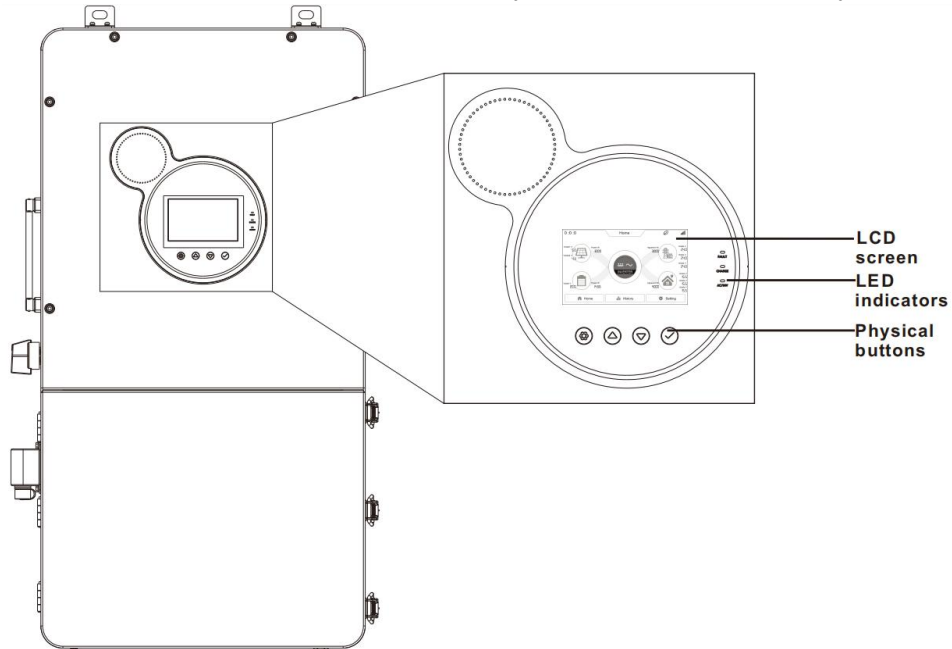

5. Operating Instructions

5.1 Operation interface

The operation interface of the inverter includes 1 LCD display, 3 LED indicators, and 4 physical buttons.



5.1.1 Physical buttons

Buttons	Functional description
	Enter or exit the Settings screen
	Jump to previous page
	Jump to the next page
	Confirm or enter the selected options











5.1.2 LED indicators

Indicator color	Function	Description
Red	FAULT	An alarm or fault event occurred
Green	CHARGE	Steady on: Charging is complete Blinking : Charging is underway
Yellow	AC/INV	Steady on: The grid output with load Blinking : The inverter output with load

5.1.3 LCD screen

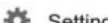

The main page displays elements:

Icon	Description	Icon	Description
	Solar panel		Load
	Battery		Grid or Generator
	Home page button		Inverter
	History data		Setting
0 : 0 : 0	Local time		The buzzer On/Off
	Indicates that the machine is currently in energy-saving mode		The energy direction
UPS	UPS load (connected to inverter load port)	HOME	HOME load (connected to grid port)

5.1.4 Real time data

5.1.4.1 System information

Click the inverter icon on the LCD home screen to view the system information of the device. The following information is displayed:

System information			
1	device state	11	SN code
2	MCU1 software version	12	Compiled version
3	LCD version	13	Rated power
4	MCU2 software version	14	RS485 address
5	Custom id number	15	External temperature
6	Inverter temperature	16	MPPT temperature
7	Transformer temperature	17	Internal L1 phase voltage
8	Internal L1 phase current	18	Internal L2 phase voltage
9	Internal L1 phase current	19	Positive bus voltage
10	Negative bus voltage	20	Total bus voltage

5.1.4.2 Battery information

Click the battery icon on the LCD home screen to view the battery information. The following information is displayed:

Battery information			
1	SOH (State of health)	6	SOC (Percentage of remaining battery capacity)
2	Battery voltage	7	Battery charging current
3	Battery power (Negative is charging, positive is discharging)	8	Battery discharging current
4	BMS communication protocol	9	Battery type
5	Battery charging state		

5.1.4.3 Photovoltaic information

Click the solar panel icon on the LCD home screen to view the Photovoltaic information. The following information is displayed:

Photovoltaic information			
1	MPPT 1 output voltage	5	MPPT 1 output current
2	MPPT 1 output current	6	MPPT 2 output power
3	MPPT 1 output power	7	MPPT output total power
4	MPPT 2 output voltage		

5.1.4.4 Grid or generator information

Click the grid icon on the LCD home screen to view the grid or generator information. The following information is displayed:

Grid or generator information			
1	L1 phase voltage	7	L2 phase voltage
2	L1 phase current	8	L2 phase current
3	L1 phase active power (Positive is to sell electricity, negative is to buy electricity)	9	L2 phase active power (Positive is to sell electricity, negative is to buy electricity)
4	L1 phase apparent power	10	L2 phase apparent power
5	Frequency	11	Charging current
6	Today' s on-grid energy		

5.1.4.5 Load information

Click the load icon on the LCD home screen to view the load information. The following information is displayed:

Load information			
1	L1 phase load voltage	7	L2 phase load voltage
2	L1 phase ups load current	8	L1 phase ups load current
3	L1 phase ups load active power	9	L2 phase ups load active power
4	L1 phase ups load apparent power	10	L2 phase ups load apparent power
5	Frequency	11	UPS load ratio
6	L1 phase home load active power	12	L2 phase home load active power

Notice:

When the device is used in parallel, L1/L2 ups load active power may be less than 0, indicating that there is a small power circulation in the parallel system, which is related to the inconsistent wiring length of the device and the inconsistent photovoltaic power and other factors, and does not have much impact on the work of the entire parallel system.

5.1.5 Historical information

Click the "History" icon at the bottom of the main page to view historical battery statistics and historical fault information.

5.1.5.1 Electricity statistics for the day

Today			
1	The amount of battery charge today	4	The load consumes electricity today
2	The amount of battery discharge today	5	The amount of charge from grid
3	Photovoltaic power generation today	6	The load consumes electricity from the grid Today

5.1.5.2 Last week's electricity statistics

Last week			
1	Photovoltaic power generation in the last 7 days	4	The amount of battery charge from grid in the last 7 days
2	The amount of battery charge in the last 7 days	5	The load consumes electricity in the last 7 days
3	The amount of battery discharge in the last 7 days	6	The load consumes electricity from the grid in the last 7 days

5.1.5.3 Accumulative electricity statistics

Accumulative			
1	Accumulative battery charge energy of the battery	5	Accumulative discharge energy of the battery
2	Total photovoltaic power generation	6	The total power consumed by the load
3	Total charging capacity from the grid	7	The total power consumed from grid by the load
4	Total on grid energy		

5.2 Parameter setting

Click the "Settings" button in the menu bar below the main page to enter the Settings page, which contains five Settings: basic Settings, working mode Settings, battery Settings, grid-connected Settings and advanced Settings.

5.2.1 Basic setting

5.2.1.1 display setup

The screenshot shows the 'Basic setup' interface with the 'Display' tab selected. It includes a 'CANCEL' and 'OK' button at the top right. The settings are as follows:

- Language: English
- RS485 Address: 1
- Screen always on:
- Beep:
- Screen brightening time: 60.00 S
- Backlight brightness: 100 %

- 1. Language:** Select the language for the display.
- 2. RS485 Address:** Set the RS485 address for the inverter, range: 1-255.
- 3. Screen always on:** Choose whether the display screen should always remain on.
- 4. Beep:** Enable or disable the beep alarm sound.
- 5. Screen brightening time:** The delay time of screen backlight turns off.
- 6. Backlight brightness:** Percentage of screen backlight brightness.

5.2.1.2 Date and time

The screenshot shows the 'Basic setup' interface with the 'Time' tab selected. It includes a 'CANCEL' and 'OK' button at the top right. The settings are as follows:

- Year: 2001
- Month: 01
- Day: 01
- Hour: 00
- Minute: 00
- Second: 00

1. Click the number of Year/Month/Day/Hour/Minute/Second, then pop-up numeric keypad.
2. Enter the correct date and time.
3. Click the "OK" button.
4. After the setting is successful, "Configuration successful" is displayed, otherwise "Configuration unsuccessful" is displayed.

5.2.1.3 Password setup

The screenshot shows the 'Basic setup' interface with the 'Password setting' tab selected. It includes a 'CANCEL' and 'OK' button at the top right. The settings are as follows:

- New Password: 0
- Confirm Password: 0

To enter the grid-connected Settings and advanced Settings, you need to enter the password. The default password is "00000", and the password setting value range is 0-65535.

5.2.2 Operating mode setting

5.2.2.1 Basic mode of operation

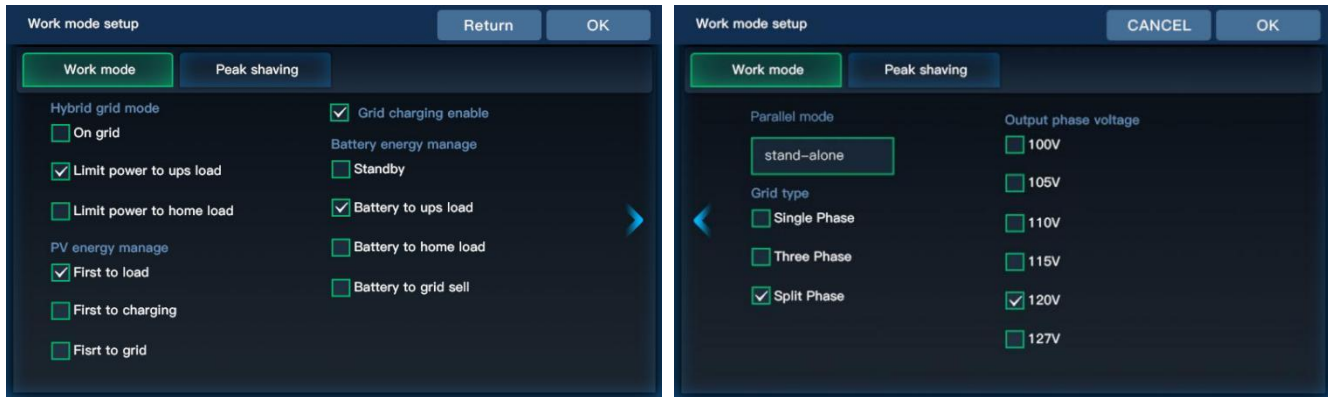

1. Hybrid grid mode: Select the device to work in grid-connected power generation mode or anti-flow mode.

- ◆ **"on grid"** means PV energy can be connected to the grid to sell electricity,
- ◆ **"limit to ups load"** means PV or battery power is only provided to the ups load, no electricity is sold,
- ◆ **"limit to home load"** means PV or battery power is only provided to the ups load and home load, no electricity is sold.
- ◆ **"AC coupling"** means the on-grid inverter connect to the hybrid inverter

Notice:

"UPS load" refers to the load connected to the "load" port of the device. "Home load" refers to the load connected to the "Grid" port of the device.

2. PV energy manage: This parameter is used to select the priority of PV energy.

- ◆ **"First to load"** means that the photovoltaic energy is supplied to the load first, the battery is charged after the load power is satisfied, and the remaining power will be feed into grid.
- ◆ **"First to charging"** means that the photovoltaic energy is supplied to battery first, and then supplied to load after the charging power is satisfied, and the remaining power will be feed into grid.
- ◆ **"First to grid"** means that the PV energy is preferentially supplied to the load, and then feed into the grid after meeting the load power, and finally the remaining power is used to charge the battery.

Notice:

When "Hybrid grid mode" is set to "limit power to ups load", the above "load" refers to the ups load. When "Hybrid grid mode" is set to "limit power to home load" and CT function is enabled, the above "load" refers to UPS load and home load.

3. Grid charging enable: Choose whether to enable the grid charging function. If enabled, the PV function is charged preferentially and the grid power is used as a supplement.

4. Battery energy manage: This parameter is used to select the battery discharge option.

- ◆ **"Standby"** means that the battery is not discharged in the hybrid mode, but only discharged in the off-grid

mode.

- ◆ **"Battery to ups load"** means that the battery discharge power is only supplied to the ups load, and the discharge power is less than or equal to the ups load power.
- ◆ **"Battery to home load"** means that the battery discharge power is only supplied to the ups load and Home load, and the discharge power is less than or equal to the ups load power + home load power.
- ◆ **"Battery to grid sell"** means that the discharging power of the battery participates in the grid sell, and the discharging power is less than or equal to the ups load power + home load power + selling power.

⚡ Notice:

When the battery and PV supply the load at the same time, the PV power is preferred and the battery power is used as a supplement. When the battery and grid supplies the load at the same time, the battery power is given priority and the grid power is used as a supplement.

5. Grid type: Select the AC wiring type. The device supports European standard single-phase, American standard three-phase and American standard split phase wiring.(Turn off the "ON/OFF" switch can be set)

- ◆ When **"single-phase"** is set, the default voltage of L1-L2 is 230V, L1 is connected to the fire line, and L2 is connected to the zero line.
- ◆ When **"three-phase"** is set, the phase voltage of L1 and L2 is 120V, the line voltage is 208V, and the phase difference between the L1 and L2 is 120°.
- ◆ When **"split phase"** is set, the phase voltage of L1 and L2 is 120V, the line voltage is 240V, and the phase difference between the L1 and L2 is 180°.

⚡ Notice:

The wiring of the device must be the same as the wiring of the parameter setting.

6. Parallel mode: This parameter is used to set the device parallel mode and is associated with the AC wiring type parameter. When the AC wiring type is set to "single phase" or "split phase", the parallel mode parameters can be selected as "stand-alone" or "parallel".

When the AC wiring type is set to "three phases", the parallel mode parameters can be set to "Three phase A" or "Three phase B" or "Three phase C".

7. Output phase voltage: Set the output voltage in the off-grid state, which refers to the phase voltage of L1-N and L2-N. The options you can set are: 100V,105V,110V, 115V,120V,127V.

5.2.2.2 Peak shaving



Work mode setup					
Work mode		Peak shaving			
<input type="checkbox"/> Timed charging enable					
	Start Time	End Time	Stop SOC	Stop Volt	Max Power
①	00 : 00	00 : 00	100%	60.0V	60W
②	00 : 00	00 : 00	100%	60.0V	60W
③	00 : 00	00 : 00	100%	60.0V	60W
<input type="checkbox"/> Timed discharging enable					
	Start Time	End Time	Stop SOC	Stop Volt	Max Power
①	00 : 00	00 : 00	100%	60.0V	60W
②	00 : 00	00 : 00	100%	60.0V	60W
③	00 : 00	00 : 00	100%	60.0V	60W

This series has a time-division charging and discharging function, and users can set different charging and discharging periods according to the local peak and valley electricity price, so that the grid and photovoltaic energy can be used reasonably.

When the grid electricity price is expensive, the battery inverter is used to supply power to the load. When the grid electricity price is cheap, the grid electricity can be used to power and charge the load, which can help the user save the electricity bill to the

greatest extent.

- 1. Timed charging enable:** Select whether to enable the timed charging feature.
- 2. Timed discharging enable:** Select whether to enable the timed discharging feature.
- 3. Start time:** Sets the start time of the timing period.
- 4. End time:** Sets the end time of the timing period.
- 5. Stop SOC:** Set the charge or discharge cut-off SOC in the timing period. This parameter is only valid if BMS communication is normal.
- 6. Stop Voltage:** Set the charge or discharge cut-off voltage in the timing period. This parameter is valid when there is no BMS communication.
- 7. Max power:** Set the maximum charging or discharging power in the timing period.

Here is a case example to help you understand this feature:

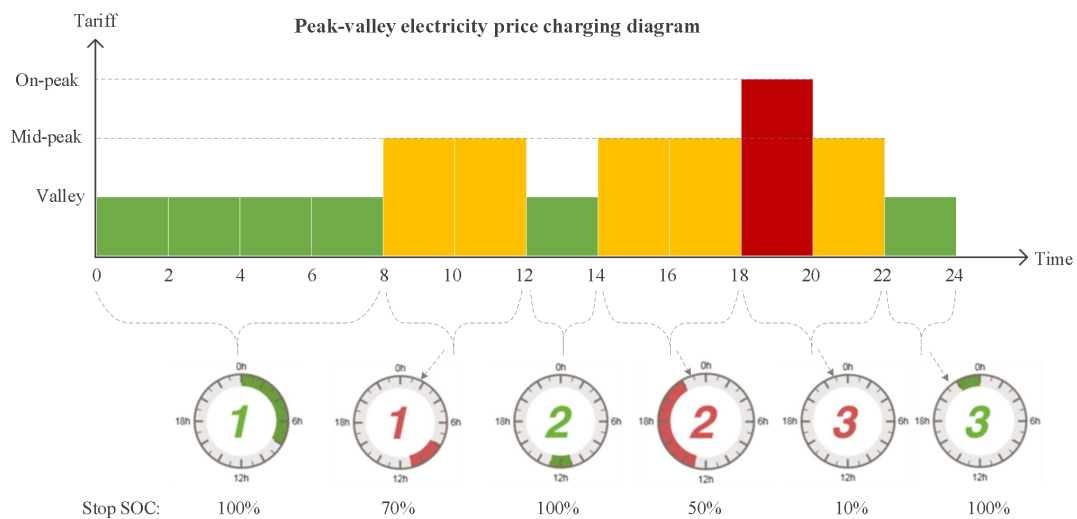

⚡ Notice:

1. Before using this function for the first time, please set the local date and time, and then you can set the corresponding time period according to the local peak and valley electricity charges.
2. In the figure above, the green period is the timing charging period, and the red period is the timing discharge period.

5.2.3 Battery parameter setting

5.2.3.1 Battery basic setting

- ◆ **Battery type:** This parameter selects the type of battery, please choose the parameters consistent with your battery.

Type	description
User define	All parameters can be set
SLD	sealed lead acid battery
FLD	Open lead-acid battery
GEL	Colloidal lead acid battery
LFP14/15/16	Lithium iron phosphate battery with 14/15/16 cells
N13/ N14	Ternary lithium battery with 13/14 cells
No battery	No battery connection

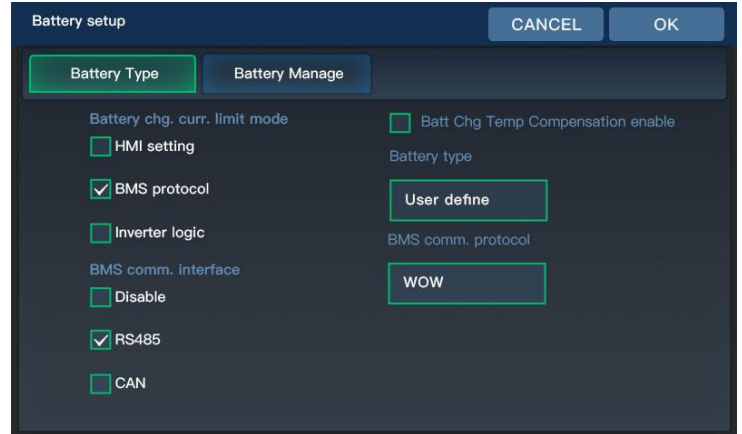

- ◆ **BMS comm. Interface:** Choose BMS communication interface, according to the actual battery BMS interface to choose RS485 interface or CAN interface.
- ◆ **BMS comm. protocol:** Choose the communication protocol that matches your battery BMS.

NO.	Brand	Protocol name	type
1	PACEEX	PACE	485 protocol
2	RADAR	RUDA	485 protocol
3	AUTOONE	AOGUAN	485 protocol
4	OLITER	OULITE	485 protocol
5	CFGE	CEF	485 protocol
6	Sunwoda	XINWANGDA	485 protocol
7	Dyness	DAQIN	485 protocol
8	SRNE	WOW	485 protocol
9	Pylon tech	PYL	485 protocol
10	FOX ESS	MIT	485 protocol
11	Xinyi energy	XIX	485 protocol
12	PowMr	POL	485 protocol
13	GOTION	GUOX	485 protocol
14	SMK POWER	SMK	485 protocol
15	VILION	VOL	485 protocol
16	SGP	SGP	485 protocol
17	GSL energy	GSL	485 protocol
18	Pylon tech 2	PYT	485 protocol
19	UZENERGY	UZE	CAN protocol

- ◆ **Battery chg. Curr. limit. mode:** Select the battery charging current limit mode. "HMI" refers to the maximum

charging current parameter set through the screen as the current limit value for battery charging. "BMS" means reading the maximum charging current limit given by the battery through BMS communication. "Inverter" means that the charging current is limited by using the current limiting logic built into the inverter, this is used for those battery BMS that do not have a current limiting function according to the SOC, the current limiting logic is shown in the following table:

SOC	Charge current limit value
≥98%	0.0625 * Irate (about 12.5A)
≥95%	0.0125 * Irate (about 25A)
≥90%	0.025 * Irate (about 50A)
≥85%	0.5 * Irate (about 100A)
< 85%	1.0 * Irate (about 200A)

Irate: Rated maximum charging current.

- ◆ **Battery Chg. Temp compensation:** Select whether to enable external temperature detection and battery charging temperature compensation function, only some models have this function.

5.2.3.2 Battery manage setting

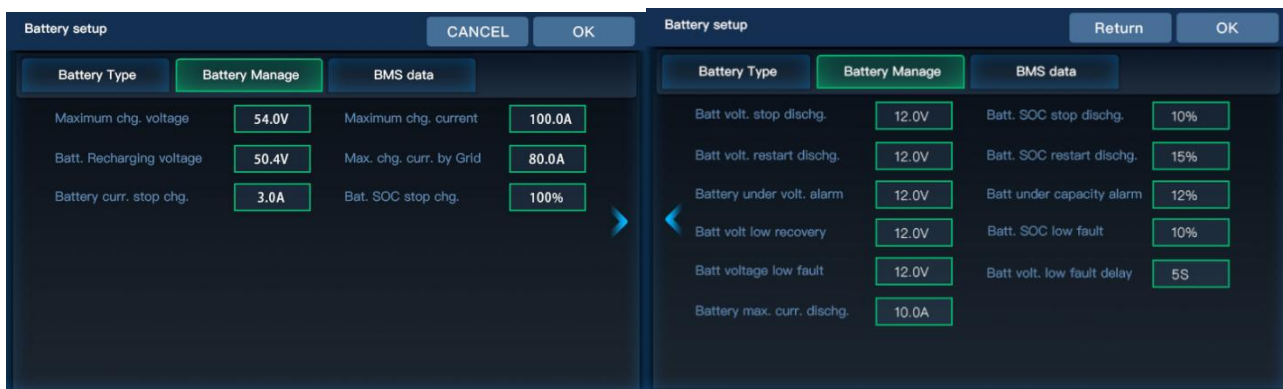

Battery management has two pages, which are switched by the arrow on the screen. The first page is used to set the charging parameters, including the following parameters:

- ◆ **Maximum chg. voltage:** Set the maximum charging voltage when the battery is charged. This parameter is read from the BMS communication when the BMS communication is normal, so it does not need to be set manually. Setup may only be required if lead-acid batteries or battery BMS communication fails.
- ◆ **Maximum chg. current:** Set the maximum charging current when the battery is charged. This parameter is read from BMS communication when BMS communication is normal and does not need to be set manually. Setup may only be required if lead-acid batteries or battery BMS communication fails.
- ◆ **Batt. Recharging voltage:** After the battery is full, the inverter stops charging, and when the battery voltage falls below this voltage value, it resumes charging again. This parameter is invalid when BMS communication is normal.
- ◆ **Battery Curr. stop chg.:** Stop charging when the charging current is less than the set value, and this parameter is invalid when BMS communication is normal.
- ◆ **Max. chg. Curr. by Grid:** When using the grid charging, this parameter is used as the limit value of the grid charging current to the battery, which is the current value of the battery side, not the current value of the AC side.
- ◆ **Batt. SOC stop chg.** When the SOC value reaches the set value, the device will stop charging the battery, which

is effective when the BMS communication is normal.

The second Settings page is about battery discharge parameters, containing the following parameters:

- ◆ **Batt. volt. stop dischg.** : Set the battery stop discharge voltage in the hybrid mode, when the battery voltage is less than or equal to the parameter value, the battery will stop discharging, and no alarm event.
- ◆ **Batt. soc. stop dischg.** : Set the battery stop discharge capacity in the hybrid mode, when the remaining battery capacity is less than or equal to the parameter value, the battery will stop discharging, no alarm event.
- ◆ **Batt volt. restart dischg.** : Set the restart discharge voltage in the hybrid mode, and when the battery voltage is greater than or equal to the parameter value, the battery enters the discharge state.
- ◆ **Batt. SOC restart dischg.** : Set the restart discharge capacity in the hybrid mode. When the battery capacity is greater than or equal to the parameter value, the battery enters the discharging state.
- ◆ **Battery under volt. Alarm:** Set the battery undervoltage alarm value. When the battery voltage is less than the parameter value, the "01" fault code alarm prompt is generated, but the device is not shut down.
- ◆ **Batt. under cap. Alarm:** Set the battery undercapacity alarm value. When the remaining battery capacity is less than the parameter value, the "30" fault code alarm prompt is generated, but the device is not shut down.
- ◆ **Batt volt. low recovery:** Set the battery voltage low fault recovery value, when the battery voltage is higher than the parameter value, the device will clear the "04" fault code.
- ◆ **Batt. SOC low fault:** Set the low protection value of battery capacity. When the remaining battery capacity is lower than the value, the battery stops discharging and the "32" fault code is generated. If the device is working in the off-grid state, the device will turn off the output at this time.
- ◆ **Batt voltage low fault:** Set the low voltage protection value of the battery. When the battery voltage is lower than the value, the battery stops discharging and the "04" fault code is generated. If the device is working in the off-grid state, the device will turn off the output at this time.
- ◆ **Batt. volt. low delay time:** Set the battery voltage low protection fault delay time in seconds.
- ◆ **Battery max. Curr. dischg.** : Set the maximum discharge current value of the battery in the hybrid mode, which is given by the BMS when the BMS communication is normal. The device will control the discharge power so that the battery current does not exceed this parameter value.

⚡ Notice:

All voltage parameters are valid when there is no BMS communication, and all capacity parameters are valid when the battery BMS communication is normal.

5.2.3.3 Battery BMS data

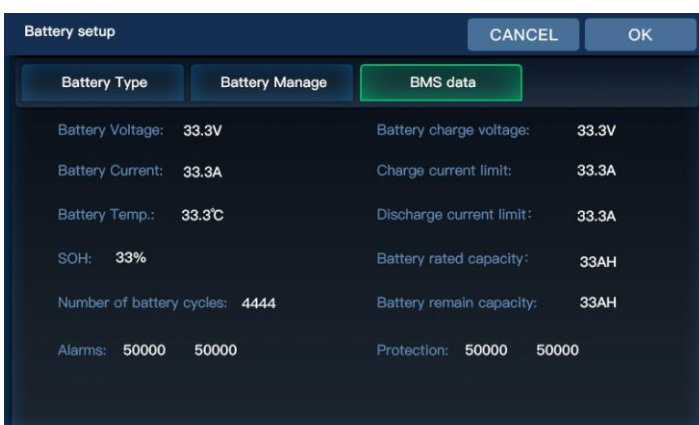

Battery setup		CANCEL		OK	
Battery Type		Battery Manage		BMS data	
Battery Voltage:	33.3V	Battery charge voltage:	33.3V		
Battery Current:	33.3A	Charge current limit:	33.3A		
Battery Temp.:	33.3°C	Discharge current limit:	33.3A		
SOH:	33%	Battery rated capacity:	33AH		
Number of battery cycles:	4444	Battery remain capacity:	33AH		
Alarms:	50000 50000	Protection:	50000 50000		

In the "BMS data" TAB page, some raw data information about the battery read from the BMS is displayed, including data such as battery voltage, battery current, battery remaining capacity, battery rated capacity, battery charging limit voltage, charging and discharging limit current.

5.2.4 Grid parameter setting:



The screenshot shows the 'On grid setup' screen with the following parameters:

- Grid standard:** UL1741&IEEE1547.1-2020
- Grid frequency:** 50Hz (unchecked), 60Hz (checked)
- Sell Power Max:** 6000W
- Buy Power Max:** 6000W
- External CT ratio:** 2000:1
- zero-export power:** 20W
- On Grid Reactive Power:** 0%
- On Grid PF:** 1.000
- Reactive power over excited:** (checked)
- Reactive power under excited:** (unchecked)
- Power factor over excited:** (checked)
- Power factor under excited:** (unchecked)

You will need to enter a password to access this page, the default password is "0000". The parameter page has grid-connected basic function Settings, grid enter service Settings, grid protection Settings and other function Settings.

5.2.4.1 grid basic function Settings

- ◆ **Grid standard:** Choose the local grid-connected standard.

Grid standard	Region
RULE21	California
HECO	Hawaii
UL1741&IEEE1547.1-2020	The rest of the United States
GNL	Areas without on-grid standards

- ◆ **Grid frequency:** To select the grid frequency, it is usually not necessary to manually select, and the device will automatically adapt according to the grid frequency.
- ◆ **Sell Power Max. :** To set the maximum selling power feed into the grid.
- ◆ **Buy Power Max. :** To set the maximum power consumption from the grid.
- ◆ **CT ratio:** To set the CT sensor conversion ratio. The standard CT conversion ratio of the device is 2000:1, which does not need to be modified by default. Setting is only required when the customer is configuring the CT sensor with different variable ratios.
- ◆ **Zero-export power:** It is used to set the power error when working in anti-flow mode. It is recommended to set 20-100W.
- ◆ **On Grid Reactive Power:** It is used to set the reactive power, the default value is 0%, usually the user does not need to change.
- ◆ **On Grid PF:** It is used to set the power factor of the grid-connected current, the default value is 1.00, usually the user does not need to change.

5.2.4.2 Grid enter service Settings (This setting is not recommended to be changed by customers)



This page is used to set the voltage frequency of connecting to the grid. According to the requirements of the grid connection standard, the voltage and frequency of the grid must be within the set parameter range before the grid connection can be started, otherwise the device will remain off-grid operation.

"Connect delay time" is the waiting time used to set the grid connection. It means that after the grid voltage and frequency meet the requirements, the device needs to

wait for the time set by this parameter before connecting to the grid.

The "connect power ramp rate" is used to set the increase rate of the grid-connected power after the connection. This parameter indicates the time it takes for the grid-connected power to increase from 0 to the rated power.

5.2.4.3 Grid protection Settings(This setting is not recommended to be changed by the customer)



This page is used to set the grid over voltage, under voltage, over frequency and under frequency protection values, and its default parameter values will be set according to the requirements of the grid-connected standard.

Among them, the range of the primary protection parameter is relatively narrow, and the range of the secondary protection parameter is relatively large.

Notice:

The voltage value in the parameters is the line voltage between the L1 and L2 phases, which is rated at 240V for split phase and 208V for three-phase. All time parameters are given in milliseconds.

5.2.4.4 Other function Settings (This setting is not recommended to be changed by customers)

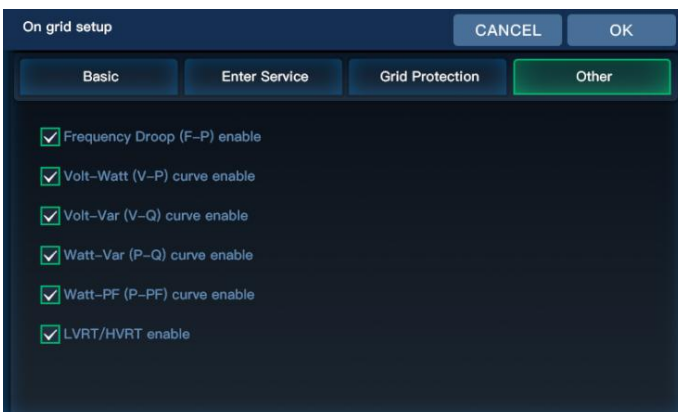

This page allows you to choose whether to enable some features of the grid standard, including the following parameters:

- ◆ **Frequency Droop enable:** This function regulates the grid-connected active power of the inverter according to the grid frequency.
- ◆ **Volt-Watt curve enable:** This function regulates the grid-connected active power of the inverter according to the grid voltage.

- ◆ **Volt-Var curve enable:** This function regulates the grid-connected reactive power of the inverter according to the grid voltage.
- ◆ **Watt-Var curve enable:** This function is to regulate the reactive power according to the active power output of the inverter.
- ◆ **Watt-PF curve enable:** This function is to adjust the power factor according to the active power output of the inverter.
- ◆ **LVRT/HVRT enable:** The low voltage ride-through and the high voltage ride-through.

5.2.5 Advanced setting

5.2.5.1 Generator



In the "Generator" TAB, you can set whether to enable the generator to charge the battery or not, and the maximum current for charging. The "Generator rate power" parameter represents the rated power of the generator, please input the rated power value on the generator nameplate into this parameter.

When the generator works, the energy is preferentially supplied to the load. When the sum of the load power and the charging power is greater

than the rated power of the generator, the device will automatically reduce the charging power to avoid overload of the generator. When the load power is greater than the rated power, the device reports overload and shuts down the output.

The "Generator work mode" parameter sets the functionality of the Generator port, the default is "Generator input". It can also be set to "**Micro inverter input**". When set to this function, please ensure that the generator port is connected to the micro grid-connected inverter. Please refer to the wiring diagram for connection method. And it also can be set as "**Smart load**", when set to this function, please ensure that the generator port is connected to the load.

5.2.5.2 Other

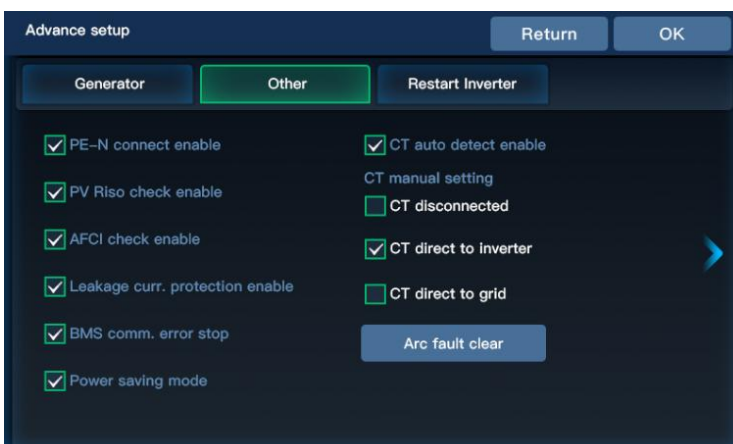

PE-N connect enable: Select whether to enable the PE-N automatic switching function.

PV Riso check enable: Select whether to enable the photovoltaic insulation impedance detection function.

AFCI check enable: Select whether to enable the photovoltaic arc detection function.

Leakage Curr. protection enable: Enable leakage protection function.

BMS comm. Error stop: Select whether to enable

BMS communication failure shutdown function. When the BMS communication fails, the battery stops discharging

and charging, and if it is in the off-grid state at this time, the output will stop.

Power saving mode: Choose whether to enable power saving mode. In the off-grid state, the inverter will enter the energy-saving mode after 5 minutes in the no-load state (load less than 25Watt). The output voltage will be turned off, and the load will be detected for 10 seconds every 3 minutes. When the load power is greater than 40Watt, the energy-saving mode will be withdrawn.

In the hybrid grid state, after the power-saving mode is turned on, the device will increase the battery discharge power to reduce the energy consumption from the grid as much as possible.

CT function operation

To enable CT and work properly, follow these steps:

1. Make sure that the CT wiring is correct. Each device is equipped with two CT sensors, which share an RJ45 interface. Firstly, insert the RJ45 plug of the CT into the interface marked with "CT" in the terminal box of the equipment. Then, the CT marked with the L1 character is stuck on the L1 phase power grid cable, and the CT marked with the L2 character is stuck on the L2 phase power grid cable. For CT wiring diagram, please refer to the Wiring instructions section.

⚡ Notice:

Please pay attention to the phase sequence and cannot be connected in reverse.

Special attention should be paid to the location where the CT should be installed at the grid entry point, that is, between the household load junction box and the grid entry meter.

2. Installation direction of CT. There is a symbol with an arrow printed on the surface of the CT sensor, which is the direction of the CT. Normally, when installing the CT, please point the arrow of the CT to the inverter. If the CT arrow points to the grid, that's fine, but make sure that the direction of the two CT sensors is the same.

3. CT enable Settings. CT enable Settings in the "Other" page of the "Advanced Settings" page. There are two options: "CT auto detect enable" and "CT manual setting".

- ◆ The "CT auto detect enable" parameter can be used to automatically detect the mounting direction of the CT. Usually, after the first installation and boot, this parameter will be enabled by default to identify the installation direction of the CT. After successful identification, the enable will be automatically turned off, and the identification result will be synchronized to the "CT manual setting" parameter.
- ◆ The "CT manual setting" parameter is used to manually set the orientation of the CT. If you are clear about the orientation of the CT, you can set the orientation of the CT manually.

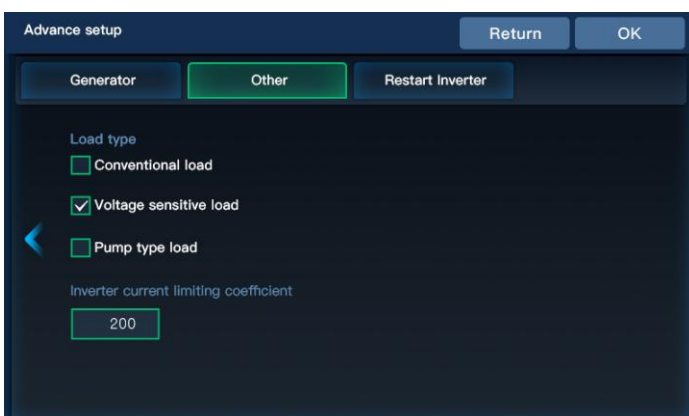

Load type: Select the type of special load, this parameter usually does not need to be set. But if you run into any of the following problems you can try changing this parameter.

1. If the local grid voltage waveform is unstable, resulting in frequent switching from the hybrid state to the off-grid state (the grid is not outage), you can try to choose the "Conventional Load".
2. If there are frequent power outages in the local power grid, and the load terminal is connected with loads that

are sensitive to voltage, such as fixed-frequency air conditioners. Try selecting "Voltage sensitive load".

3. If the local power grid has frequent power outages, and the load is connected to the motor load of the pump. Try selecting "Pump type load".

Inverter current limiting coefficient: This parameter is used to limit the off-grid inverter output current and usually does not need to be set.

5.2.5.3 Restart Inverter

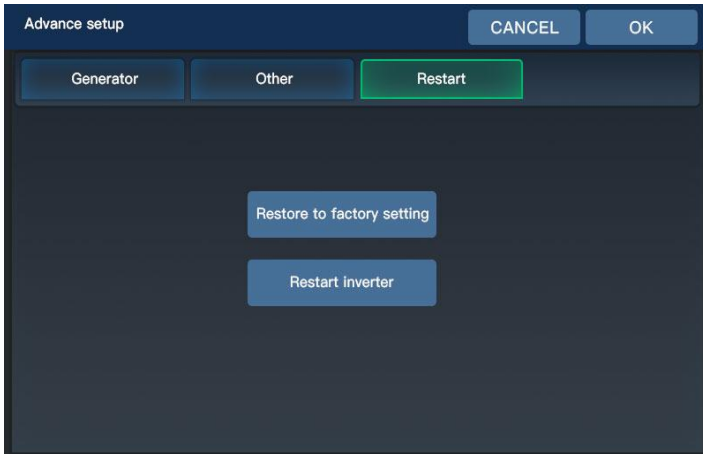

Steps to restore factory Settings:

1. Click the "Restore to factory setting" button, and a dialog box will pop up. Click "OK" to confirm, and "configuration successful" will be displayed to indicate that the command to restore the factory setting was successfully issued.
2. Then click the "restart inverter" button and click "OK" to confirm that the inverter will restart.
3. After the device reboots successfully, the parameter will be restored to the factory state.

5.3 Recommended Settings

5.3.1 Peak and valley electric charges

Applicable scene: The grid is relatively stable and has peak and valley electricity prices. It is expected to realize economic benefits or reduce electricity costs through the price difference.

Do you want to sell electricity?	Hybrid grid mode	CT function	PV energy manage	Batt. energy manage	Grid charge enable	On grid max. power	Peak shaving
Yes	On grid	Disable	First to charging	Battery to grid sell	Ignore	0~Rated power	enable
No	Limit power to ups load	Disable	First to charging	Battery to ups load	Ignore	0~Rated power	enable
No	Limit power to home load	Enable	First to charging	Battery to home load	Ignore	0~Rated power	enable

How this scenario works:

(1) Its main logic is to perform timed charging and discharging.

(2) During the timed charging period:

- ◆ When grid charging or grid and PV mixed charging, ignoring the forbidden setting of "Grid charge enable".
- ◆ Grid charging power is determined by the power setting value in each charging period.
- ◆ When grid and PV mixed charging, if the PV has residual energy, it can be carried out with load or feed into grid.

(3) During the timed discharging period:

- ◆ When the battery discharges until the voltage or capacity is lower than the set "stop discharge voltage or SOC" parameter, the battery stops discharging, and the grid will not charge the battery; When there is a PV, the PV can charge the battery.
- ◆ When discharging, the discharge power does not exceed the discharge power value set in each time period.

5.3.2 Generate power for self use

Applicable scene: The grid is more stable, no peak and valley electricity price, and the photovoltaic energy is maximized to reduce the cost of electricity.

Do you want to sell electricity?	Hybrid grid mode	CT function	PV energy manage	Batt. energy manage	Grid charge enable	On grid max. power	Peak shaving
Yes	On grid	Disable	First to load	Battery to ups load	Disable	0~Rated power	Disable
	On grid	Enable	First to load	Battery to home load	Disable	0~Rated power	Disable
No	Limit power to ups load	Disable	First to load	Battery to ups load	Disable	Ignore	Disable
	Limit power to home load	Enable	First to load	Battery to home load	Disable	Ignore	Disable

How this scenario works:

- (1) The photovoltaic energy is preferentially supplied to the load, and the residual energy after meeting the load power is used to charge the battery.
- (2) When the PV power is insufficient to supply the load or there is no PV, the battery discharges to replenish the energy.
- (3) When PV and battery are loaded at the same time, PV power is given priority to the load.
- (4) forbid grid charging and reduce grid electricity consumption.

5.3.3 Priority to sell electricity

Applicable scene: The grid is more stable, no peak and valley electricity price, the price of selling electricity is higher than the price of buying electricity. It is expected that economic gains can be achieved by prioritizing electricity sales.

Do batteries sell electricity?	Hybrid grid mode	CT function	PV energy manage	Batt. energy manage	Grid charge enable	On grid max. power	Peak shaving
Yes	On grid	Disable	First to load	Battery to grid sell	Disable	0~Rated power	Disable
	On grid	Enable	First to load	Battery to grid sell	Disable	0~Rated power	Disable
No	On grid	Disable	First to load	Battery to ups load	Disable	0~Rated power	Disable
	On grid	Enable	First to load	Battery to home load	Disable	0~Rated power	Disable

How this scenario works:

- (1) Implement the logic of selling electricity first.
- (2) The photovoltaic energy has the priority to sell electricity. After meeting the selling power, the remaining energy will charge the battery.
- (3) Photovoltaic power to meet the selling power refers to photovoltaic output power \geq UPS load power + Home load power + set selling power. Because the photovoltaic energy must first pass through the load, and then feed into the grid.
- (4) When the photovoltaic power is weak, the battery power is used as a supplement, and the amount of the supplement power depends on the setting of the "battery energy management" parameter.

5.3.4 Battery storage charge

Applicable scene: The power grid is unstable, and frequent power outages occur. It is expected to give priority to improving the reserve of the remaining battery capacity for use in case of power outages.

Do you want to sell electricity?	Hybrid grid mode	CT function	PV energy manage	Batt. energy manage	Grid charge enable	On grid max. power	Peak shaving
Yes	On grid	Disable	First to charging	Standby	Enable	0~Rated power	Disable
No	Limit power to ups load	Disable	First to charging	Standby	Enable	Ignore	Disable

How this scenario works:

- (1) Perform the logic of priority charging to improve battery reserve.
- (2) When there is power grid and PV, start hybrid charging, and PV energy is preferred.

- (3) After the PV energy meets the charging power, the residual energy is provided to the load.
- (4) When the power grid outage, the device switches to the battery inverter output, if there is PV, PV and battery hybrid inverter output, PV energy priority.
- (5) After the battery power is exhausted, the device is dry contact action. If there is a diesel generator, the diesel generator is started to connect to carry out the load.
- (6) When the diesel generator is connected, it is decided whether to charge the battery according to the setting of the "Generator charging enable" parameter.
- (7) The power of the diesel generator is preferentially loaded, and the charging power is dynamically adjusted according to the power of the load to ensure that the power of the load + charging will not exceed the power value set by the parameter of the "Generator rated power".

5.4 Battery parameter

- Lead-acid battery

Battery type Parameters	Sealed lead acid battery	Gel lead acid battery	Flooded lead acid battery	User-defined
	SLd	GEL	FLd	USE
Overdisconnect Voltage	60V	60V	60V	60V
Boost charging voltage	57.6V	56.8V	57.6V	40~60V (can be set)
Undervoltage alarm voltage	44V	44V	44V	40~60V (can be set)
Undervoltage disconnect voltage	42V	42V	42V	40~60V (can be set)
Discharge limiting voltage	40V	40V	40V	40~60V (can be set)
Overdischarge delay time	5s	5s	5s	1~30s (can be set)
Enhanced Charge Cycle	120min	120min	120min	10~900min (can be set)

- Li-ion batter

Battery type Parameters	Ternary		LFP			User-defined
	N13	N14	L16	L15	L14	USE
Overdisconnect Voltage	60V	60V	60V	60V	60V	60V
Boost charging voltage	53.2V	57.6V	56.8V	53.2V	49.2V	40~60V (can be set)
Undervoltage alarm voltage	43.6V	46.8V	49.6V	46.4V	43.2V	40~60V (can be set)
Undervoltage disconnect voltage	38.8V	42V	48.8V	45.6V	42V	40~60V (can be set)
Discharge limiting voltage	36.4V	39.2V	46.4V	43.6V	40.8V	40~60V (can be set)
Overdischarge delay time	30s	30s	30s	30s	30s	1~30s (can be set)
Enhanced Charge Cycle	120min (can be set)	120min (can be set)	120min (can be set)	120min (can be set)	120min (can be set)	10~900min (can be set)

6. Communication

6.1 Overview

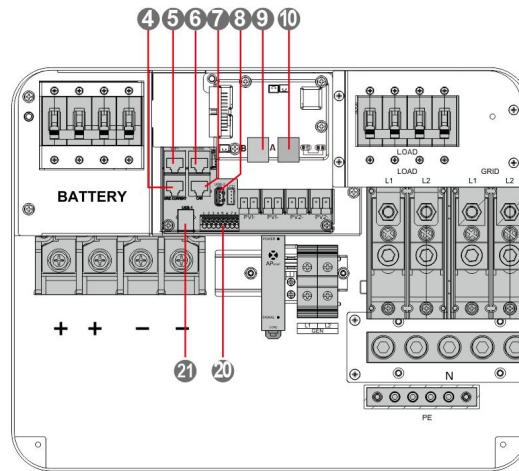

4	External CT port	9	Parallel port B
5	WIFI port 1	10	Parallel port A
6	BMS RS485 port	20	Dry contact
7	BMS CAN port	21	USB-A port
8	USB-B port		

6.2 USB-B port

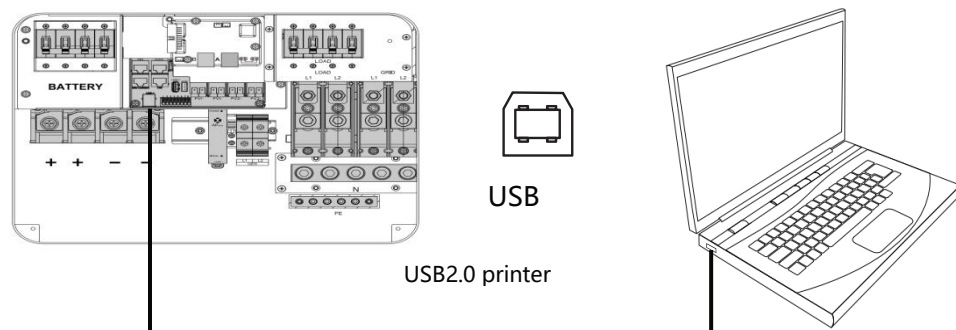

The user can read and modify device parameters through this port by using the host software. Please contact us for the host software installation package if you require one.

6.3 WIFI

The WIFI port is used to connect to the Wi-Fi/GPRS data acquisition module, which allows users to view the operating status and parameters of the inverter through the cell phone APP. **Only can connect one port**

WIFI port 1:

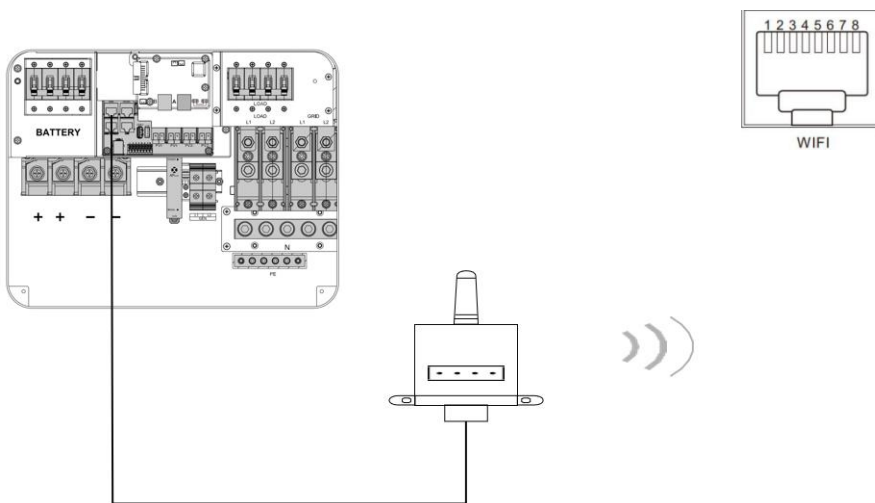

RJ45	Definition
Pin 1	5V
Pin 2	GND
Pin 3	/
Pin 4	/
Pin 5	/
Pin 6	/
Pin 7	RS485-A
Pin 8	RS485-B

WIFI port 2:

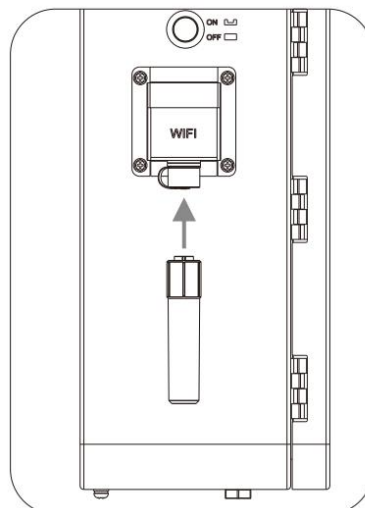

The RS485 port is used to connect to the BMS of Liion battery.

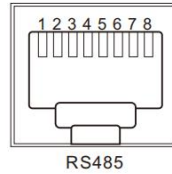

RJ45	定义
Pin 1	/
Pin 2	/
Pin 3	/
Pin 4	CANH
Pin 5	CANL
Pin 6	/
Pin 7	RS485-A
Pin 8	RS485-B

6.5 CAN port

The CAN port is used to connect to the BMS of Liion battery .

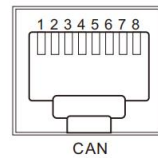

RJ45	Definition
Pin 1	/
Pin 2	/
Pin 3	/
Pin 4	CANH
Pin 5	CANL
Pin 6	/
Pin 7	/
Pin 8	/

① NOTICE

If you need the inverter to communicate with the lithium battery BMS, please contact us for the communication protocol or to upgrade the inverter to the corresponding software program.

6.6 External CT port

1. Length of CT Output Line Wrap: 4m
2. Normally The CT direction is "to inverter"

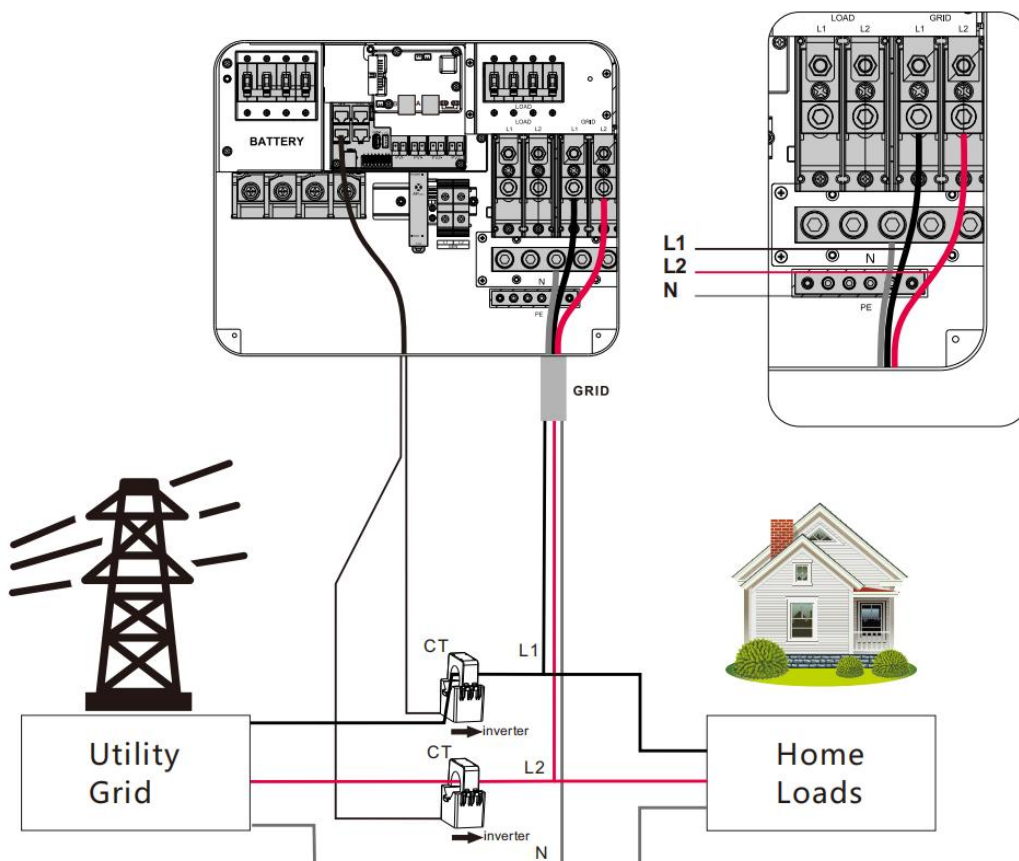
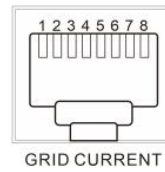

3. Current transformer (CT) dimensions:(mm)

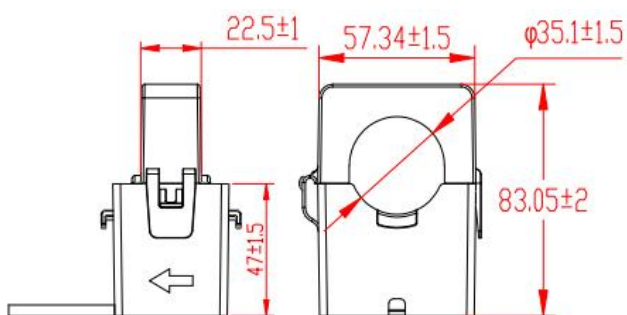

laser engraving



fuse side

6.7 Dry contact

Dry contact port with 3 functions:

1. RSD power supply
2. Temperature sampling (reserved)
3. Generator remote start/stop

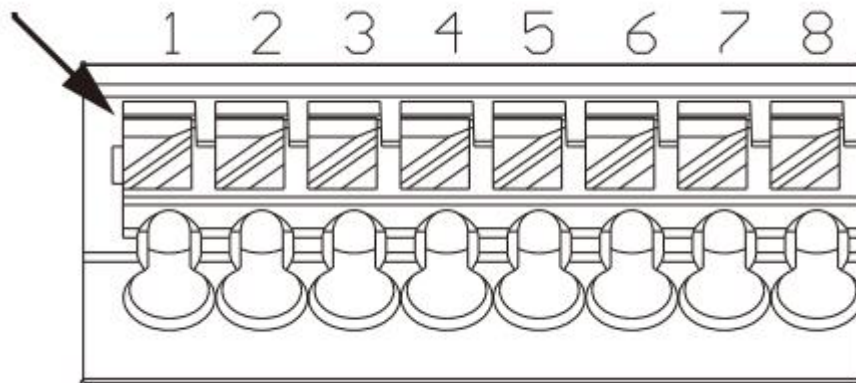

Function	Description
RSD power supply	PIN 1 is GND, PIN 2 is RSD 12V+
Temperature sampling (reserved)	Pin 1 & Pin 5 can be used for battery temperature sampling compensation.
Generator remote start/stop	<p>When the generator is connected, the following conditions need to be met.</p> <ol style="list-style-type: none"> 1、 Remote start the generator when there is no grid connection. 2、 When there is no BMS connection, the generator will be remotely started when the battery voltage is below the undervoltage alarm threshold or when the battery switches to the grid voltage. 3、 When connected to the BMS, the generator will be remotely started when the battery SOC is lower than the set point for switching to grid SOC. 4、 When there is no BMS connection, the generator will be remotely stopped when the battery voltage reaches the voltage threshold for switching from grid to battery, or when the battery is fully charged. 5、 When the BMS is connected, the generator will be remotely shut down when the battery SOC is lower than the set value for switching from grid to battery SOC. 6. Remote shutdown of the generator when the battery is fully charged. <p>Remote start of the generator: Pin 6 to Pin 7 is normally open, Pin 7 to Pin 8 is normally closed.</p> <p>Remote generator shutdown: Pin 6 to 7 is normally closed, Pin 7 to 8 is normally open.</p> <p>(Pin 6/7/8 outputs 125Vac/1A, 230Vac/1A, 30Vdc/1A)</p>

NOTICE

If you need to use the remote start/stop function of the generator with dry contact, ensure that the generator has ATS and supports remote start/stop.

7. Fault and Remedy

7.1 Fault code

Fault code	Fault name	Whether it affects the output or not	Description
01	BatVoltLow	Yes	Battery undervoltage alarm.
02	BatOverCurrSw	Yes	Battery discharge average current overcurrent (software protection).
03	BatOpen	Yes	Battery not-connected alarm
04	BatLowEod	Yes	Battery undervoltage stop discharge alarm.
05	BatOverCurrHw	Yes	Battery overcurrent (hardware protection)
06	BatOverVolt	Yes	Charging overvoltage protection
07	BusOverVoltHw	Yes	Bus overvoltage (hardware protection)
08	BusOverVoltSw	Yes	Bus overvoltage (software protection)
09	PvVoltHigh	Yes	PV overvoltage protection.
10	PvBoostOCSw	No	Boost overcurrent (software protection)
11	PvBoostOCHw	No	Boost overcurrent (hardware protection)
12	HESCommErr	Yes	Master-slave HES communication failure
13	OverloadBypass	Yes	Bypass overload protection
14	OverloadInverter	Yes	Inverter overload protection.
15	AcOverCurrHw	Yes	Inverter overcurrent hardware protection
16	AuxDspReqOffPWM	Yes	Requesting a shutdown fault from the chip
17	InvShort	Yes	Inverter short-circuit protection.
18	Bussoftfailed	Yes	Bus soft start failure
19	OverTemperMppt	No	Buck heat sink over temperature protection
20	OverTemperInv	Yes	Inverter AC output with load or AC charging radiator over-temperature protection.
21	FanFail	Yes	Fan blockage or failure fault
22	EEPROM	Yes	Memory failure
23	ModelNumErr	Yes	Model setting error

24	Busdiff	Yes	Positive and negative bus voltage imbalance
25	BusShort	Yes	Busbar short circuit
26	Rlyshort	Yes	Inverter AC output backfeed to bypass AC output
28	LinePhaseErr	Yes	Utility input phase error
29	BusVoltLow	Yes	Low bus voltage protection
30	BatCapacityLow1	Yes	Alarm given when battery capacity rate is lower than 10% (setting BMS to enable validity).
31	BatCapacityLow2	No	Alarm given when battery capacity rate is lower than 5% (setting BMS to enable validity).
32	BatCapacityLowStop	Yes	Inverter stops when battery capacity is low (setting BMS to enable validity).
34	CanCommFault	Yes	CAN communication fault in parallel operation.
35	ParaAddrErr	Yes	Parallel ID (communication address) setting error.
37	ParaShareCurrErr	Yes	Parallel current sharing fault
38	ParaBattVoltDiff	Yes	Large battery voltage difference in parallel mode.
39	ParaAcSrcDiff	Yes	Inconsistent AC input source in parallel mode.
40	ParaHwSynErr	Yes	Hardware synchronization signal error in parallel mode.
41	InvDcVoltErr	Yes	Inverter DC voltage error.
42	SysFwVersionDiff	Yes	Inconsistent system firmware version in parallel mode.
43	ParaLineContErr	Yes	Parallel line connection error in parallel mode.
44	Serial number error	Yes	No serial number set at factory
45	Error setting of split-phase mode	Yes	Item "Parallel" setting error
49	Grid over voltage	Yes	Selects the local corresponding grid standard.
50	Grid under voltage	Yes	
51	Grid over Frequency	Yes	
52	Grid under Frequency	Yes	
53	Grid loss	Yes	

54	Grid DC current over	Yes	
55	Grid standard un init	Yes	
56	Low insulation resistance fault	No	PV1+, PV2+ and PV- abnormally low impedance to ground.
57	Leakage current overload fault	Yes	System leakage current exceeds limit.
58	BMSComErr	No	BMS communication failure
60	BMSUnderTem	No	BMS alarm battery low temperature.
61	BMSOverTem	Yes	BMS alarm battery over temperature. (Effective after successful BMS communication)
62	BMSOverCur	Yes	BMS alarm battery over current. (Effective after successful BMS communication)
63	BMSUnderVolt	No	BMS alarm low battery. (Effective after successful BMS communication)

7.2 Troubleshooting

Fault code	Faults	Remedy
Display	No display on the screen	Check if the battery switch or PV switch is closed; whether the switch is in the "ON" state; press any button on the screen to exit the screen sleep mode
【06】	Battery overvoltage protection	Check that the battery voltage does not exceed the protection value. If it does, discharge the battery until the voltage falls below the battery over-voltage recovery point.
【01】 【04】	Battery undervoltage protection	Charge the battery until it returns to the low voltage disconnection recovery voltage.
【21】	Fan failure	Check if the fan is not turning or blocked by foreign object.
【19】 【20】	Heat sink over temperature protection	When the temperature of the device is cooled below the recovery temperature, normal charge and discharge control is resumed.
【13】 【14】	Bypass overload protection, inverter overload protection	① Reduce the use of power equipment; ② Restart the unit to resume load output.
【17】	Inverter short-circuit protection	① Check the load connection carefully and clear the short-circuit fault points; ② Re-power up to resume load output.
【09】	PV overvoltage	Use a multimeter to check if the PV input voltage exceeds the maximum allowable input voltage rated.
【03】	Battery disconnected alarm	Check if the battery is not connected or if the battery circuit breaker is not closed.
【40】 【43】	Parallel connection fault	Check if the parallel line is not connected well, such as loose or wrong connection.
【35】	Parallel ID setting error	Check whether the setting of parallel ID number is repeated.
【37】	Parallel current sharing fault	Check if the parallel current sharing line is not connected well, such as loose or wrong connection.
【39】	Inconsistent AC input source in parallel mode	Check whether the parallel AC inputs are from the same input interface
【42】	Inconsistent system firmware version in parallel mode	Check whether the software version of each inverter is consistent.

【44】	Serial number error	Incorrect device serial number setting.
【45】	Parallel mode error	There is a device in the parallel system with the wrong parallel mode setting.
【49】	High grid voltage	Check that the grid voltage is within the normal range, if the grid voltage is abnormal, wait until the grid voltage is restored.
【50】	Low grid voltage	Check that the grid voltage is within the normal range, if the grid voltage is abnormal, wait until the grid voltage is restored.
【51】	High grid frequency	Check that the grid frequency is within the normal range, if the grid frequency is abnormal, wait until the grid frequency is restored.
【52】	Low grid frequency	Check that the grid frequency is within the normal range, if the grid frequency is abnormal, wait until the grid frequency is restored.
【53】	Grid unconnected	Check if the grid is correctly connected, e.g. if the switch is closed and if the grid is disconnected.
【54】	Grid-connected current with DC component over	Power down and restart the device, if it continues to report faults, contact the manufacturer after sales.
【55】	Grid standard not set	Setting standards for grid integration
【56】	Low insulation resistance fault	Check that the system is well grounded and that the PV modules and cables are not worn
【57】	Leakage current overload fault	Check that the system is well grounded and that the loads are not operating abnormally.

NOTICE

If you encounter a fault with the product that cannot be solved by the methods in the table above, please contact our after-sales service for technical support and do not disassemble the equipment yourself.

8. Protection and Maintenance

8.1 Protection features

No	Protection Feature	Instruction
1	PV current limiting protection	When the charging current or power of the PV array configured exceeds the PV input rated value, the inverter will limit the input power and charge at the rated.
2	PV input over-voltage	If the PV voltage exceeds the maximum value allowed by the hardware, the machine will report a fault and stop the PV boost to output a sinusoidal AC wave.
3	PV night reverse current protection	At night, the battery is prevented from discharging through the PV module because the battery voltage is greater than the voltage of PV module.
4	Utility input overvoltage protection	When the mains voltage exceeds 140Vac, the mains charging will be stopped and the output will be inverted.
5	AC input under-voltage protection	When the mains voltage falls below 90Vac, the mains charging will be stopped and the output will be inverted.
6	Battery over-voltage protection	When the battery voltage reaches the over-voltage cut-off point, the PV and the utility will automatically stop charging to prevent the battery from being overcharged and damaged.
7	Battery under-voltage protection	When the battery voltage reaches the under-voltage cut-off point, the inverter will automatically stop the battery discharge to prevent damage from over-discharging the battery
8	Battery over-current protection	After a period when the battery current exceeds that allowed by the hardware, the machine will switch off the output and stop discharging the battery.
9	AC output short-circuit protection	When a short-circuit fault occurs at the load output for more than 200ms, the output AC voltage will be turned off immediately, and then manually re-powered and turned on before normal output can be restored. (Non-utility bypass condition)
10	Heat sink over-temperature protection	When the internal temperature of the inverter is too high, the inverter will stop charging and discharging; when the temperature returns to normal, the inverter will resume charging and discharging.

11	Inverter over-load protection	After triggering the overload protection the inverter will resume output after 3 minutes, 5 consecutive overloads will switch off the output until the inverter is restarted.
12	AC output reverse	Prevents AC back flow from the battery inverter to the bypass AC input.
13	Bypass over-current protection	Built-in AC input over-current protection circuit breaker
14	Bypass phase inconsistency protection	When the phase of the bypass input and the phase of the inverter split do not match, the inverter disables switching to the bypass output to prevent the load from dropping out or short-circuiting when switching to the bypass.

8.2 Maintenance

To maintain optimum and long-lasting working performance, we recommend that the following items are checked twice a year.

1. Ensure that the airflow around the inverter is not blocked and remove any dirt or debris from the radiator.
2. Check that all exposed conductors are not damaged by sunlight, friction with other surrounding objects, dry rot, insect or rodent damage, etc. The conductors need to be repaired or replaced if necessary.
3. Verify that the indications and displays are consistent with the operation of the equipment, note any faults or incorrect displays and take corrective action if necessary.
4. Check all terminals for signs of corrosion, insulation damage, high temperatures or burning/discolouration and tighten terminal screws.
5. Check for dirt, nesting insects and corrosion, clean as required, Clean the insect screen regularly.
6. If the lightning arrester has failed, replace the failed arrester in time to prevent lightning damage to the inverter or other equipment of the user.

**⚠ DANGER**

- Make sure that the inverter is disconnected from all power sources and that the capacitors are fully discharged before carrying out any checks or operations to avoid the risk of electric shock.

The Company shall not be liable for damage caused by :

1. Damage caused by improper use or use in a wrong location.
2. Photovoltaic modules with an open circuit voltage exceeding the maximum permissible voltage.
3. Damage caused by the operating temperature exceeding the restricted operating temperature range
4. Dismantling and repair of the inverter by unauthorised persons.
5. Damage caused by force majeure: damage during transport or handling of the inverter.

MODEL	HEBP4880U200-Pro	HEBP48100U200-Pro	HEBP48120U200-Pro	Settable
Inverter output				
Rated Output Power	8800W	10,000W	@240V 12000W @208V 10400W	
Max. Peak Power	1.5 times rated power			
Rated Output Voltage	120/240Vac (Split-phase) 120/208V(Three-phase)			√
Output voltage error	@240V 36.6A @208V 42.3A	@240V 41.7A @208V 48.1A	50A	
Load Capacity of Motors	5HP	6HP	6HP	
Rated AC Frequency	50/60Hz			√
Waveform	Pure Sine Wave			
Parallel capacity	6			
Battery				
Battery Type	Li-ion / Lead-Acid / User Defined			√
Rated Battery Voltage	48Vdc			
Voltage Range	40-60Vdc			√
Max. Grid Charging Current	200A			√
Max. Generator Charging Current	90A			√
Max. Hybrid Charging Current	240A			√
PV input				
Num. of MPP Trackers	2			
Max. PV array power	6000W/6000W	7500W/7500W	9000W/9000W	
Max. input current	32A+32A			
Short current I _{sc}	40A+40A			
Max. Voltage of Open Circuit	550Vdc+550Vdc			
MPPT Voltage Range	125-450Vdc/125-450Vdc			
Grid / Generator input				
Input Voltage Range	90-140Vac			
Frequency Range	50/60Hz			
Maximum bypass overload phase current	200A (5S)			
Continuous Grid Passthrough Current	180A			
Efficiency				

MPPT Tracking Efficiency	99.9%	
Max Efficiency	97.5%	
CEC Efficiency	96.5%	
Basic data		
Dimensions	840*440*260mm	
Weight	48kg	
Protection Degree	IP65	
Operating Temperature Range	-25~60°C, >45°C derated	
Noise	<60dB	
Self-consumption	<100W	
Cooling Method	Heat sink + intelligent fan cooling	
Communication		
Communication port	RS485 / CAN / USB / Dry contact	√
External Modules (Optional)	Wi-Fi / GPRS	√
Certified specifications		
Safety standards	UL1741&IEEE1547.1-2020,CEC, RULE 21, HECO	
EMC	FCC 15 class B	
RoHS	Yes	