

Solar Storage Inverter

User Manual

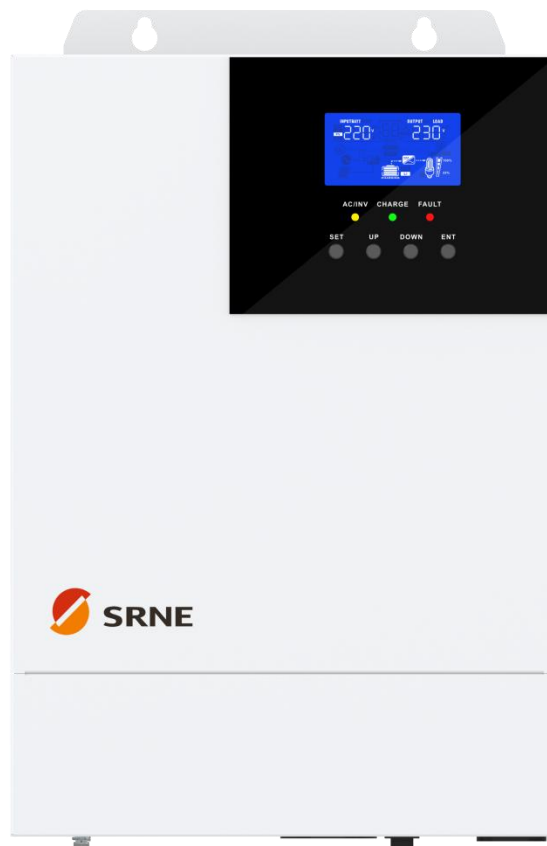

Product Model

HF1210S60-108

HF1215S60-108

Important Safety Instruction

Please keep this manual for future use.

This manual contains all safety, installation and operating instructions for HF solar storage inverter.

Please read all instructions and precautions in the manual carefully before installation and use.

- Non-safety voltage exists inside the solar storage inverter. To avoid personal injury, users shall not disassemble the solar storage inverter themselves. Contact our professional maintenance personnel if there is a need for repair.
- Do not place the solar storage inverter within the reach of children.
- Do not install the solar storage inverter in harsh environments such as moist, oily, flammable or explosive, or heavily dusty areas.
- The mains input and AC output are high voltage, so please do not touch the wiring terminals.
- The housing of the solar storage inverter is hot when it is working. Do not touch it.
- Do not open the terminal protective cover when the solar storage inverter is working.
- It is recommended to attach proper fuse or circuit breaker to the outside of the solar storage inverter.
- Always disconnect the fuse or circuit breaker near the terminals of PV array, mains and battery before installing and adjusting the wiring of the solar storage inverter.
- After installation, check that all wire connections are tight to avoid heat accumulation due to poor connection, which is dangerous.
- The solar storage inverter is off-grid. It is necessary to confirm that it is the only input device for load, and it is forbidden to use it in parallel with other input AC power to avoid damage.

Contents

1. Basic Information	5
1.1 Product overview and characteristics	5
1.2 Basic system introduction	6
1.3 Appearance	7
1.4 Dimension drawing	8
2. Installation Instruction	9
2.1 Installation Precautions	9
2.2 Wiring specifications and circuit breaker selection	10
2.3 Installation and Wiring	11
3.Operating Mode	16
3.1 Charge mode	16
3.2 Output mode	17
4. LCD screen operating instructions	18
4.1 Operation and display panel	18
4.2 Introduction to operation keys	18
4.3 Introduction to indicator light	18
4.4 Introduction to LCD screen	19
4.5 Setting parameter	22
5.Other Function	31
5.1 WIFI/RS485 communication function	31
5.2 CAN communication function	31

5.3 USB communication function	31
6.Protection	32
6.1 Protection function	32
6.2 Meaning of fault code	33
6.3 Some fault troubleshooting	35
7.System Maintenance	36
8. Technical Parameter	37

1. Basic Information

1.1 Product overview and characteristics

HF is a new solar storage inverter, which integrates solar energy storage & mains charging energy storage and AC sine wave output. Thanks to DSP control and advanced control algorithm, it has high response speed, high reliability and high industrial standard. There are four charge modes namely only solar power, mains power priority, solar power priority, mains power & solar power; inverter and mains outputs are selectable to meet different application needs.

The solar charge module adopts the latest optimized MPPT tracking technology, which can quickly track the maximum power point of the PV array in any environment to obtain the maximum energy of the solar panel in real time with wide voltage range of MPPT.

AC-DC charge module adopts advanced control algorithm to realize full digital double closed-loop control of voltage and current, with high control accuracy and small volume. Battery can be charged and protected stably and reliably with wide AC voltage input range, full input/output protection function.

DC-AC inverter module based on full digital intelligent design adopts advanced SPWM technology, outputs pure sine wave, converts DC into AC. It is suitable for AC loads such as household appliances, electric tools, industrial device, electronic audiovisual, etc. The product adopts the segment LCD display design to display the operation data and state of the system in real time. The comprehensive electronic protection function ensures that safety and stability of the whole system.

Features:

1. Adopt full digital voltage and current double closed-loop control and advanced SPWM technology to output pure sine wave.
2. Two output modes, i.e. mains bypass and inverter output can achieve uninterrupted power supply function.
3. Four optional charge modes: only solar energy, mains priority, solar energy priority and mixed charging.
4. Advanced MPPT technology, with efficiency up to 99.9%.
5. Wide MPPT voltage range.
6. With function of activating lithium battery with solar energy power, it supports connection of lead-acid battery and lithium battery.
7. LCD screen design and 3 LED indicator lights dynamically display system data and operation states.
8. ON/OFF rocker switch can control AC output.
9. With power saving mode function, it can reduce no-load loss.
10. Intelligent adjustable speed fan is adopted for efficient heat dissipation and extended system life.
11. Possessing multiple protection functions and 360° comprehensive protection.
12. Possessing complete short circuit protection, overvoltage and undervoltage protection, overload protection, back filling protection, etc.

1.2 Basic system introduction

The figure below shows the system application scenario of this product. A complete system includes the following parts:

1. PV module: convert the light energy into direct current energy and then charge the battery via the machine, or directly invert the light energy into alternating current to supply power to the load.
2. Mains or generator: connected at the AC input, it can supply power to the load and charge the battery at the same time. If no mains power or generator is connected, the system can also operate normally. At this time, the load power is supplied by the battery and PV modules.
3. Battery: the battery is to ensure the normal power consumption of the system load in case of no sufficient solar energy or mains supply.
4. Household load: it can be connected to various household and office loads, including AC loads such as refrigerators, lamps, televisions, fans, air conditioners, etc.
5. Inverter: the energy conversion device of the whole system.

The specific system wiring mode is determined by the actual application scenario.

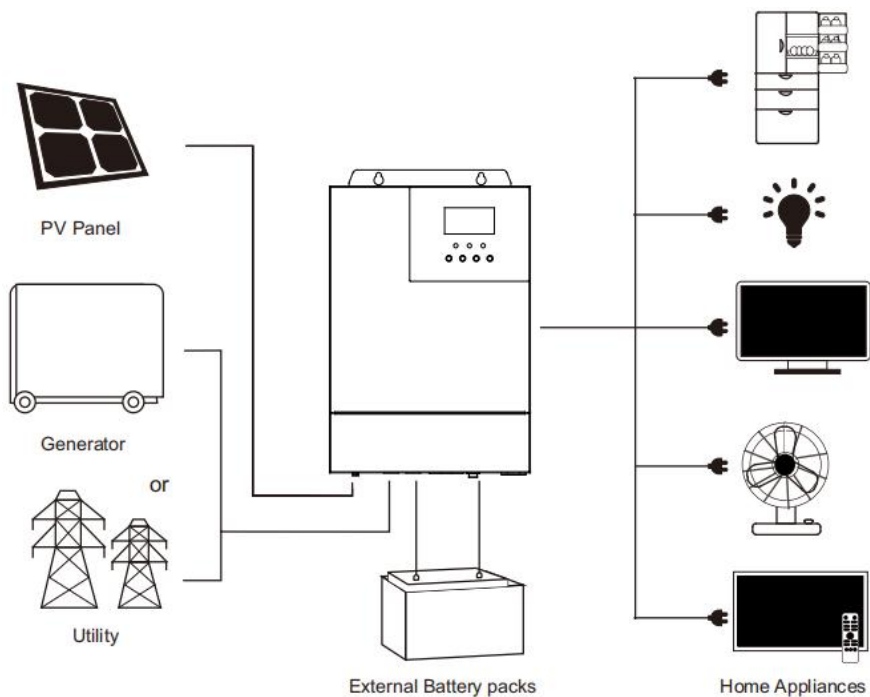

1.3 Appearance

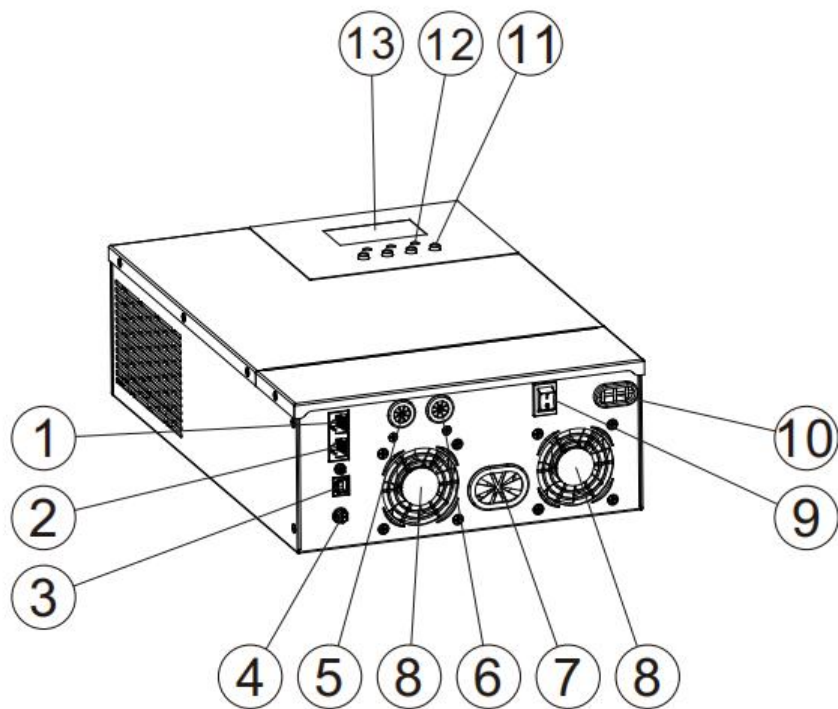

①	AC input terminal	⑨	Battery input terminal
②	AC output terminal	⑩	ON/OFF rocker switch
③	USB communication port	⑪	PV input terminal
④	WIFI/RS485 communication port	⑫	CAN communication port
⑤	Dry contact port	⑬	Touchable buttons
⑥	Grounding screw hole	⑭	LED Indicators
⑦	Overload protector	⑮	LCD screen
⑧	Cooling fan	⑯	Dust net

1.4 Dimension drawing

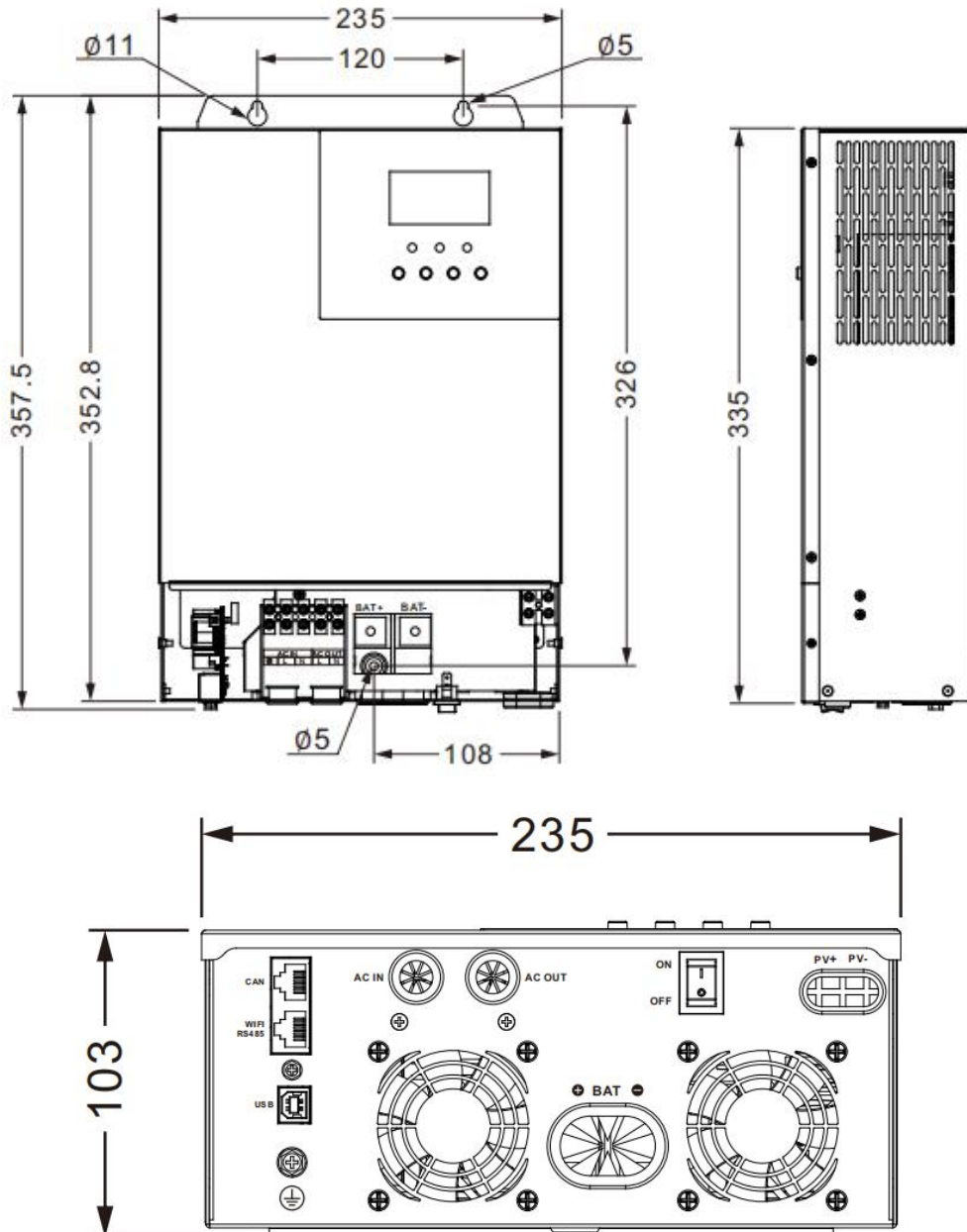

2. Installation Instruction

2.1 Installation Precautions

Before installation, please carefully read the manual and get familiar with the installation steps.

- Be very careful when installing the battery. Wear safety goggles when installing a lead-acid liquid battery. Once coming into contact with the battery acid, rinse with clean water timely.
- Do not place metal objects near the battery to prevent short-circuit of the battery.
- Acid gas may be generated when the battery is charged. So, please ensure good ventilation.
- When installing the cabinet, be sure to leave enough space around the solar storage inverter for heat dissipation. Do not install the solar storage inverter and lead-acid battery in the same cabinet to avoid corrosion by acid gas generated during battery operation.
- Only the battery that meets the requirements of the unit can be charged.
- Poorly connected connections and corroded wires may cause great heat which will melt the wire insulation, burn the surrounding materials, and even cause fires. So, make sure the connectors have been tightened, and the wires are secured with ties to avoid looseness of connections caused by shaking of wires during mobile application.
- The system connection wires are selected according to a current density of not more than 5 A/mm².
- Avoid direct sunlight and rainwater infiltration for outdoor installation.
- Even after the power is turned off, there is still high voltage inside the unit. Do not open or touch the internal components, and avoid related operations until the capacitor completely discharges.
- Do not install the solar storage inverter in harsh environments such as moist, oily, flammable or explosive, or heavily dusty areas.
- Polarity at the battery input end of this product shall not be reversed, otherwise it may damage the device or cause unpredictable danger.
- The mains input and AC output are high voltage, so please do not touch the wiring terminals.
- When the fan is working, do not touch it to prevent injury.
- It is necessary to confirm that the solar storage inverter is the only input device for load equipment, and it is forbidden to use it in parallel with other input AC power to avoid damage.

2.2 Wiring specifications and circuit breaker selection

Wiring and installation must comply with national and local electrical codes.

Recommended PV array wiring specifications and circuit breaker selection: Since the output current of the PV array is affected by the type, connection method and illumination angle of the PV module, the minimum wire diameter of the PV array is calculated according to its short-circuit current; refer to the short-circuit current value in the PV module specification (the short-circuit current is constant when the PV modules are connected in series; the short-circuit current is the sum of the short-circuit currents of all PV modules connected in parallel); the short-circuit current of the PV array shall not exceed the maximum input current.

➤ **Refer to the table below for PV input wire diameter and switch:**

Model	Recommended wiring diameter	Maximum PV input current	Recommended air switch or circuit breaker type
HF1210S60-108	9mm ² /8AWG	28.5A	2P—40A
HF1215S60-108	9mm ² /8AWG	28.5A	2P—40A

Note: the voltage in parallel shall not exceed maximum PV open-circuit voltage.

➤ **Refer to the table below for recommended AC input wire diameter and switch:**

Model	Recommended wiring diameter	Maximum bypass input current	Recommended air switch or circuit breaker type
HF1210S60-108	2mm ² /14AWG	10A	2P—10A
HF1215S60-108	2mm ² /14AWG	10A	2P—10A

Note: there is already a corresponding breaker at input connection point of mains supply. Therefore, no breaker may be equipped.

➤ **Recommended battery input wire diameter and switch selection:**

Model	Recommended wiring diameter	Rated battery discharge current	Maximum charge current	Recommended air switch or circuit breaker type
HF1210S60-108	22mm ² /3AWG	120A	95A	2P—140A
HF1215S60-108	22mm ² /3AWG	120A	120A	2P—140A

➤ **Recommended AC output wiring specifications and circuit breaker selection:**

Model	Recommended AC output wiring diameter	Maximum bypass output current	Recommended air switch or circuit breaker type
HF1210S60-108	2mm ² /12AWG	10A	2P—10A
HF1215S60-108	2mm ² /12AWG	10A	2P—10A

Note: The wiring diameter is for reference only. If the distance between the PV array and the solar storage inverter or the distance between the solar storage inverter and the battery is relatively long, using a thicker wire can reduce the voltage drop to improve system performance.

Note: The above are only recommended wiring diameter and circuit breaker. Please select the appropriate wiring diameter and circuit breaker according to actual situations.

2.3 Installation and Wiring

Installation steps:

Step 1: confirm the installation position and heat dissipation space, confirm the installation position of machine, such as wall surface; to install the machine, guarantee there is sufficient air flowing through the cooling fins of machine. At least reserve 200mm space at the left and right air outlets of the machine to guarantee heat loss through natural convection. Refer to the overall installation schematic above.



Warning: danger of explosion! Never install the machine and lead-acid liquid battery into a same sealed space or in a sealed place with probable accumulation of battery gas.

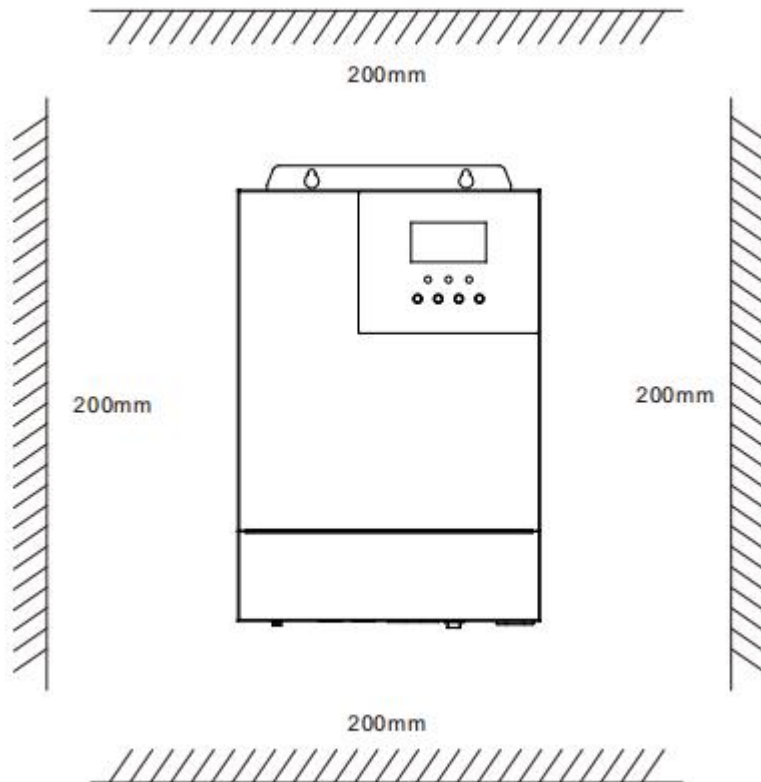

Step 2: Remove the terminal protection cover

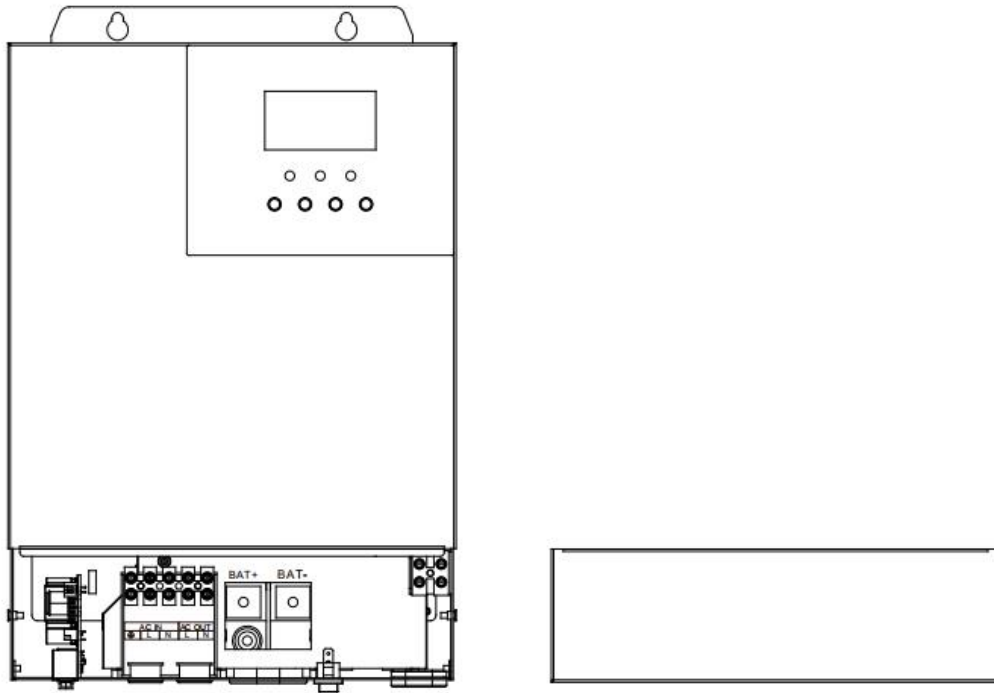

Step 3: Wiring

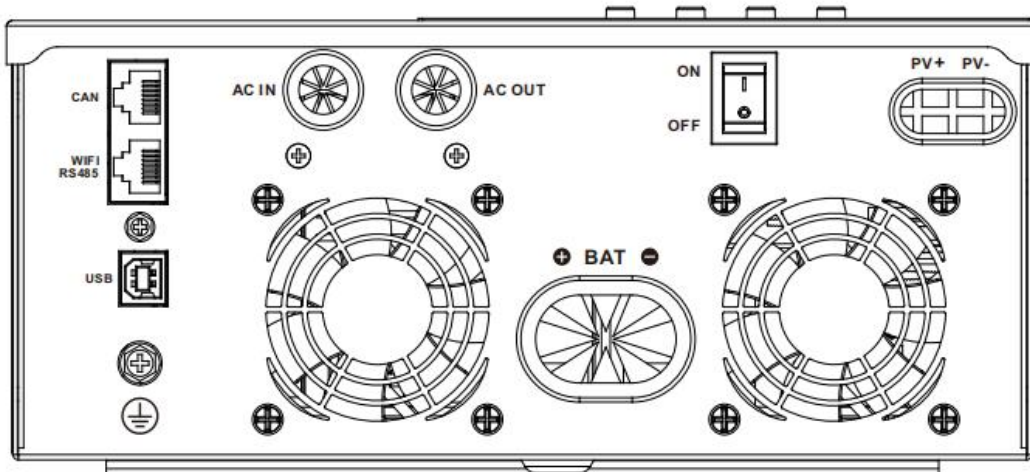

AC input/output wiring method:

- ① Before AC input/output wiring, disconnect the external breaker at first and then confirm whether the cable used is thick enough. Please refer to chapter “ 2.2 Wiring Specification and Breaker type” ;
- ② Correctly connect AC input wire in accordance with cable sequence and terminal position shown in the figure below. Please connect ground lead at first, and then live wire and null wire;

: **Ground** **L: Live** **N: Neutral**

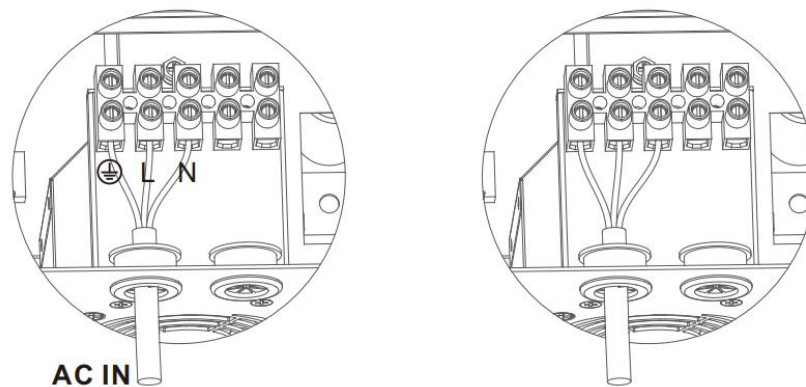

- ③ Correctly connect AC output wire in accordance with cable sequence and terminal position shown in the figure below. Please connect the ground wire at first, and then live wire and null wire. The ground wire is connected to the ground screw hold through O-type terminal.

: **Ground** **L: Live** **N: Neutral**

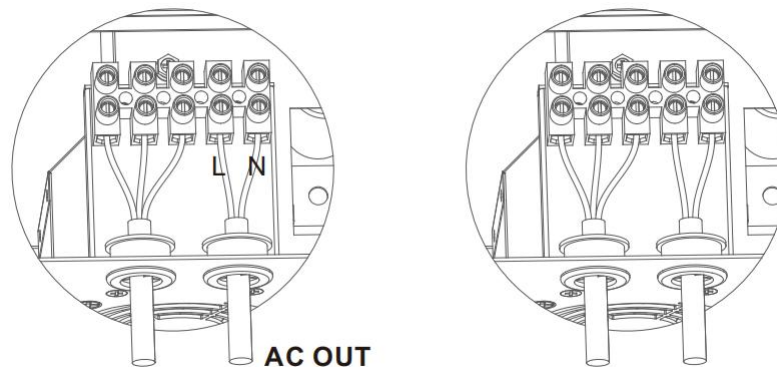

Note: The grounding wire shall be as thick as possible (cross-sectional area is not less than 4mm²). The grounding point shall be as close as possible to the solar storage inverter. The shorter the grounding wire, the better.

PV input wiring method:

- ① Prior to wiring, disconnect the external circuit breaker and confirm that the wire used is thick enough. Please refer to Section 2.2 “Wiring Specifications and Circuit Breaker Selection” .
- ② Properly connect the PV input wire according to the wire sequence and terminal position shown in the figure below.

PV+: PV positive **PV-: PV negative**

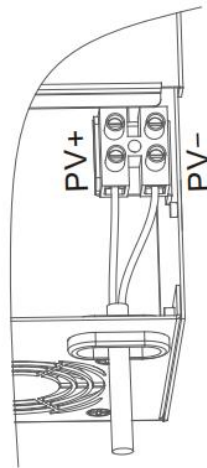

BAT wiring method:

- ① Before wiring, disconnect external breaker at first, and then confirm whether the used cable is thick enough. Please refer to chapter “ 2.2 Wiring Specification and Breaker Type ” . BAT wire shall be connected with the machine via O-shaped terminal. It is recommended to use the O-shaped terminal with 6mm inside diameter. The O-shaped terminal must compress BAT wire firmly to prevent excessive heating caused by great contact resistance.
- ② Correctly connect BAT wire in accordance with cable sequence and terminal position shown in the figure below.

BAT+: Battery positive **BAT-: Battery negative**

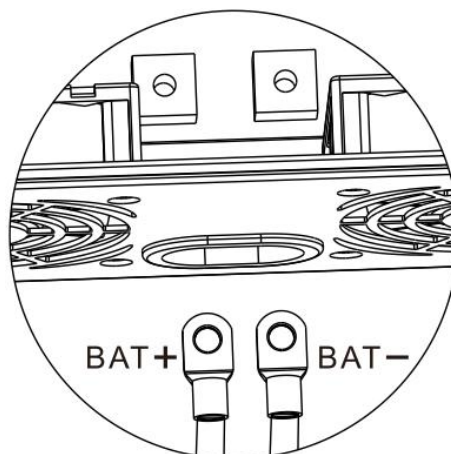

Warning notice:

- ① Input from mains supply, AC output and PV array may generate high voltage. Before wiring, make sure to break the breaker or fuse;
- ② During wiring process, make sure to pay attention to the safety; during the wiring process, please don't close the breaker or fuse. At the same time, guarantee that "+" and "-" poles of different parts are correctly connected with wires; a breaker must be installed at the battery end and selected based on chapter "2.2 Wiring Specification and Breaker Type". Before wiring, make sure to break the breaker to prevent strong electric spark generated during wiring. At the same time, avoid battery short circuit during the wiring process; if the machine is in the area with frequent thunder, it is suggested to install an external arrester at PV input terminal.

Step 4: Inspect whether the wires are correctly and firmly connected, especially whether the positive and negative input poles of the battery are correct, whether the positive and negative input poles of PV are correct, whether AC input is inaccurately connected to AC output terminal.

Step 5: Install protective cap of terminal

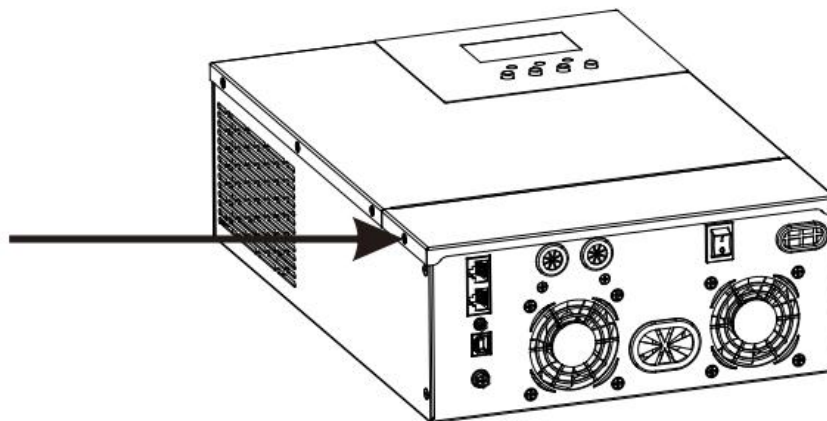

Step 6: Start the machine

At first close the breaker at the battery end, and then press the rocker switch at the lower left side of the machine to "ON" state, "AC/INV" indicator light flashes, indicating normal operation of inverter. Afterwards, close breakers of PV array and mains supply. In the end, after AC output is normal, turn on AC load one by one to avoid protection action generated by great instant impact owing to simultaneous turnon of loads. The machine operates normally in accordance with set mode.

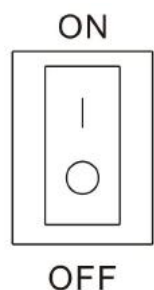

Note: if power is supplied to different AC loads, it is suggested to turn on the loads with great impact current, and then turn on the load with little impact current after the load operates stably.

Note: in case of abnormal operation of machine or abnormal display of LCD or indicator light, refer to Chapter 6 for troubleshooting.

3. Operating Mode

3.1 Charge mode

1) **PV priority:** PV module will charge the battery preferentially, and the battery is charged by the Mains only when the PV system fails. During the day, solar energy is fully used to charge, while at night, it converts to the Mains. This can maintain battery level, and is ideal for areas where the grid is relatively stable and electricity price is relatively high.

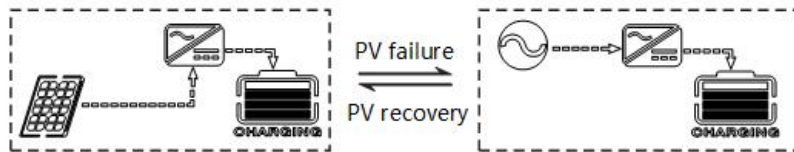

2) **Mains priority:** The Mains supply is preferentially used to charge the battery. Only when the Mains fails, the PV charging can be activated.

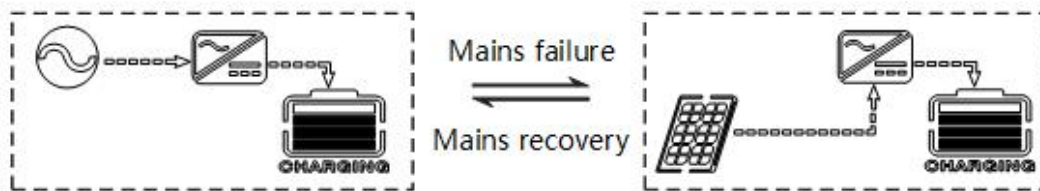

3) **Hybrid charging:** PV and mains hybrid charging. PV MPPT charging is a priority, and when PV energy is insufficient, the mains supply supplements. When the PV energy is sufficient again, the mains stops charging. This is the fastest charging mode, suitable for the areas where power grid is unstable, providing sufficient backup power supply at any time.

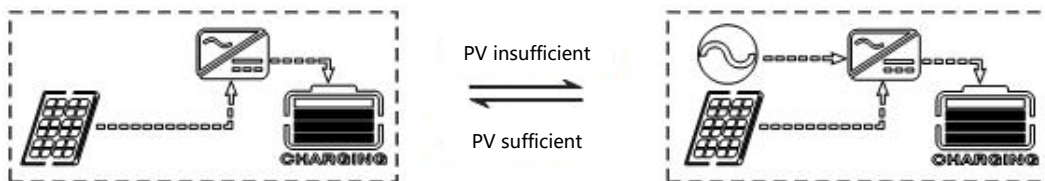

4) **Only Solar:** Only PV charging, without Mains charging. This is the most energy-efficient way in which battery is charged only by solar panels, and is usually used in areas with good lighting conditions.

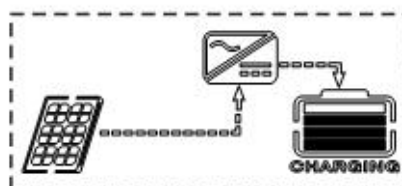

3.2 Output mode

> **PV priority mode:**

When photovoltaic is ineffective, it switches to mains power and charging. This mode maximises the use of solar energy while maintaining battery power, and is suitable for areas with relatively stable power grids.

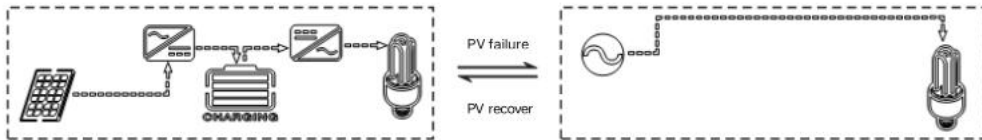

> **Mains priority mode:**

Switch to inverter power supply only when there is no utility power, and switch to utility power charging and supply when utility power recovery. The equipment is as a backup UPS, used in areas with unstable power grid. Switching does not affect the PV charging.

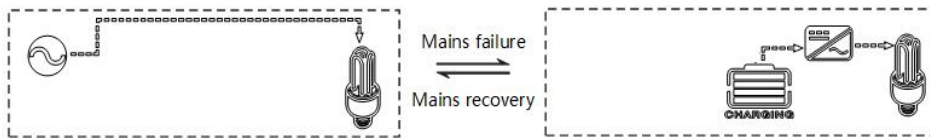

> **Inverter priority mode:**

Switches to mains power supply only when the battery discharge undervoltage is lower than the set point ([04] setting item). When the mains-charged battery is above the set point ([05] setting item), it switches to battery discharge mode, cycling the battery charge and discharge. This mode maximises the use of DC energy and is used in areas with stable power grids. Switching does not affect PV charging.

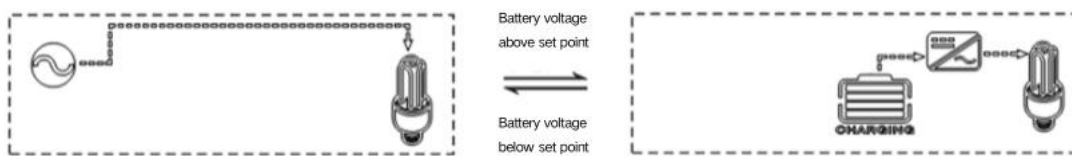

4. LCD screen operating instructions

4.1 Operation and display panel

The operation and display panel is as shown below, including 1 LCD screen, 3 indicators and 4 operation buttons.

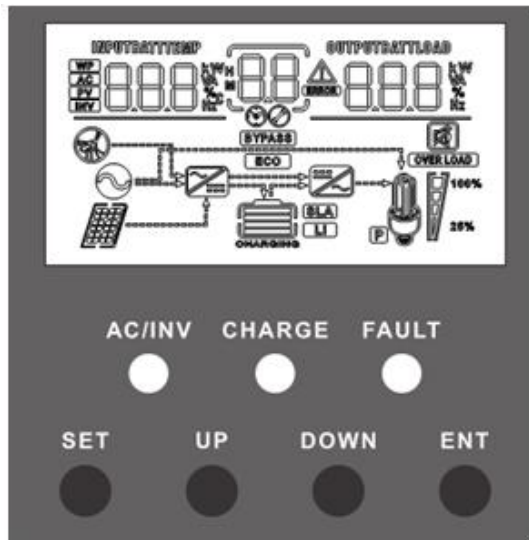

4.2 Introduction to operation keys

Function Key	Description
SET	Enter/exit setting menu
UP	Last option
DOWN	Next option
ENT	Confirm/enter option under setting menu

4.3 Introduction to indicator light

Indicator light	Color	Description
AC/INV	Yellow	Constant on: mains supply output
		Flashing: inverter output
CHARGE	Green	Flashing: battery in charge
		Constant on: charge completed





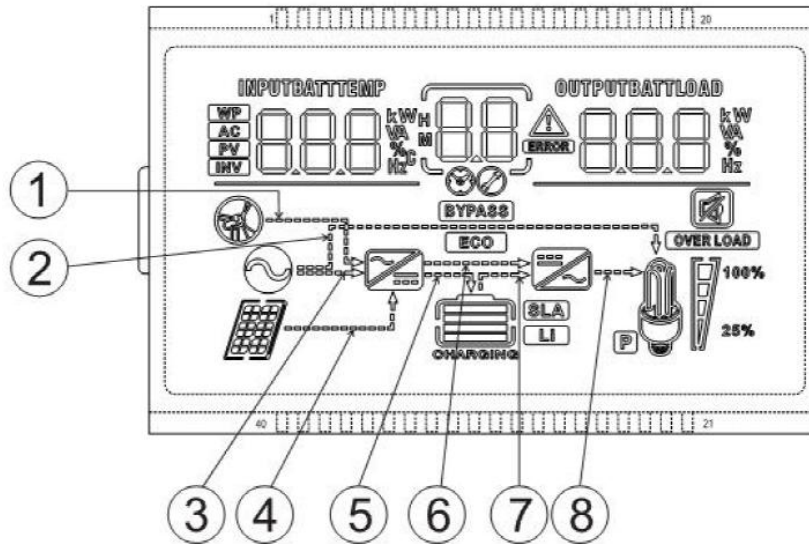











FAULT	Red	Constant on: fault state
-------	-----	--------------------------

4.4 Introduction to LCD screen



Icon	Function	Icon	Function
	Indicating that AC input end has been connected to power grid		Indicating that inverter circuit is in working.
	Indicates that the AC input mode in APL mode (wide voltage range)		Indicating that the machine is in mains supply bypass work mode
	Indicating that PV input end has been connected to solar battery panel		Indicating that AC output is in overload state
	Indicating that machine has been connected to battery, indicating 0%~24% battery remaining capacity indicating 25%~49% battery remaining capacity indicating 50%~74% battery remaining capacity indicating 75%~100% battery remaining capacity		Indicating percentage of AC output load, indicating 0%~24% load percentage, indicating 25%~49% load percentage, indicating 50%~74% load percentage, indicating ≥75% load percentage

	battery remaining capacity		
--	----------------------------	--	--

	Indicating that present battery type of the machine is lithium battery		Indicating that buzzer is not enabled
	Indicating that current battery type of machine is lead-acid battery		Indicating alarm of machine
	Indicating that the battery is in charge state.		Indicating that the machine is in fault state.
	Indicating that AC/PV charge circuit is in working		Indicating that the machine is in setting mode.
	Indicating that AC output end has AC voltage output		Middle parameter display of screen, 1. In non-setting mode, displaying alarm or fault code; 2. In setting mode, displaying code of parameter item under current setting.
Parameter display at left side of screen: input parameter			
	Indicating AC input		
	Indicating PV input		
	Indicating inverter circuit		
	The icon is not displayed		
	Displaying battery voltage, total charge current of battery, charge power of mains supply, AC input voltage, AC input frequency, PV input voltage, temperature of internal radiator, software version		
Parameter display at right side of screen: output parameter			
	Indicating output voltage, output current, output active power, output apparent power, battery discharge current, software version; under setting mode, displaying the setting parameter under the parameter item code set currently		

Arrow display			
①	The arrow is not displayed	⑤	Indicating charge from charge circuit to battery end
②	Indicating power grid power supply to load	⑥	The arrow is not displayed
③	Indicating power grid power supply to charge circuit	⑦	Indicating power supply from battery end to inverter circuit
④	Indicating PV power supply to charge circuit	⑧	Indicating power supply from inverter circuit to load

Real-time data view method

In LCD main screen, press keys "UP" and "DOWN" to turn page and view different realtime data of the machine.

Page	Parameters on the left side of the screen	Parameters in the middle of the screen	Parameters on the right side of the screen
1	INPUT BATT V (Battery input voltage)	Fault code	OUTPUT LOAD V (Output load voltage)
2	PV TEMP °C (PV charger heatsink temperature)		PV OUTPUT KW (PV output power)
3	PV INPUT V (PV input voltage)		PV OUTPUT A (PV output current)
4	INPUT BATT A (Input battery current)		OUTPUT BATT A (Battery output current)
5	INPUT BATT KW (Battery input power)		OUTPUT BATT KW (Battery output power)
6	AC INPUT Hz (AC input frequency)		AC OUTPUT LOAD Hz (AC output frequency)
7	AC INPUT V (AC input voltage)		AC OUTPUT LOAD A (AC output load current)
8	INPUT V (For maintain)		OUTPUT LOAD KVA (Load apparent power)
9	INV TEMP °C (AC charge or battery discharge heatsink temperature)		INV OUTPUT LOAD KW (Load active power)
10	APP software version		Bootloader software version
11	Model Battery Voltage Rating		Model Output Power Rating
12	Model PV Voltage Rating		Model PV Current Rating

4.5 Setting parameter

Key operation description: to enter setting menu and exit from setting menu, please press key "SET" . After entering the setting menu, parameter number 【00】 shall flash. At this time, press keys " UP " and " DOWN " to select the parameter item code to be set. Afterwards, press key " ENT " to enter parameter editing state. At this moment, the parameter value can flash. The parameter values are adjusted through keys "UP" and "DOWN" . In the end, press key "ENT" to complete parameter editing and return to parameter selection state.

Parameter No.	Parameter name	Setting	Description
00	Exit	[00] ESC	Exit from setting menu.
01	Work priority mode	[01] SOL	PV priority mode, when PV is invalid or battery value is lower than the parameter [04] setting value, it shall switch to mains power.
		[01] UTI default	Mains priority mode, it switches to inverter only when the mains power is invalid.
		[01] SBU	Inverter priority mode, switching to mains only when the battery is under-voltage or below the value set in parameter [04]; switching to battery discharge only when the battery is fully charged or above the value set in parameter [05].
02	Output frequency	[02] 50.0 default	Bypass self-adaption, it automatically adapts to mains frequency in case of mains power; without mains power, the output frequency can be set via the menu. For 230V machine, it is 50Hz by default.
		[02] 60.0	
03	AC input voltage range	[03] APL	90~280V wide range input AC voltage range of 230V machine.
		[03] UPS default	170~280V narrow range input AC voltage range of 230V machine.

04	Battery to mains	[04] 11.5V default	When parameter 【01】 = SBU, the battery voltage is lower than the set value, the output is switched to mains from battery. The setting range is 10.5V~15.5V. (The maximum value of this item cannot be set higher than item [05].)
05	Mains to battery	[05] 14V default	When parameter 【01】 = SBU, battery voltage is higher than the set value, the output is switched to battery from mains at 10.5V~15.5V setting range. (This setting minimum is affected by item [08].)
06	Charging mode	[06] CSO	PV priority charging, only when the PV charging fails, the mains charging is started.
		[06] CUB	Mains priority charging, only when the mains charging fails, the PV charging is started.
		[06] SNU default	PV and mains hybrid charging; PV charging is a priority, and when the PV energy is insufficient, the mains charging supplements. When the PV energy is sufficient, the mains charging stops. Note: Only when the mains bypass supply power to the load, the PV charging and the mains charging can work at the same time. When the inverter works, only the PV charging can be started.
		[06] OSO	Only PV charging, with the mains charging not activated.
07	Maximum charging current	[07] 60A default	S series model, setting range 0~120A.
08	Battery type	[08] USE	For user-defined, all battery parameters can be set.
		[08] SLd	Sealed lead-acid battery

		[08] FLd	Flooded lead-acid battery.
		[08] GEL default	Gel lead-acid battery.
		[08] L04	Lithium iron phosphate battery L04 corresponds to lithium iron phosphate battery 04 strings.
		[08] N04	Ternary lithium battery 4 strings.
09	Boost charging voltage	[09] 14.0V default	The setting range of boost charging voltage is 11V~15.5V . Valid when battery type is user-defined and lithium battery.
10	Boost charging maximum time	[10] 120 default	Boost maximum charging time setting, means setting of maximum charge time of voltage when the voltage reaches parameter 【09】 from 5min~900min at 5-minute step.
11	Float voltage	[11] 13.8V default	12V~15.5V setting range of float voltage at 0.4V step.

12	Over-discharging voltage	[12] 10.5V default	When the battery voltage is lower than the judgement point, after delaying for the parameter 【13】 setting time, turn off the inverter output. 10.5V~12V voltage setting range .
13	Over-discharging delay time	[13] 5S default	When the battery voltage is lower than parameter 【12】 , the inverter output is turned off after delaying the time set with the parameter. 5S~55S setting range at 5S step.
14	Battery under-voltage alarm point	[14] 11V default	When the battery voltage is lower than the judgement point, an undervoltage alarm is given out and no turnoff is output. 10.5V~14V .
15	Battery discharging limit voltage	[15] 11.2V default	When the battery voltage is lower than the judgement point, the output is turned off immediately. 10.5V~14V . Valid when battery type is user-defined and lithium battery.
16	Equalized charging	[16] DIS default	Disable equalized charging.
		[16] ENA	Enable equalized charging. Valid when battery type is flooded lead-acid batteries, sealed lead-acid batteries and user-defined.
17	Equalized charging voltage	[17] 14.2V default	12V~15.5V s. Valid when battery type is flooded lead-acid batteries, sealed lead-acid batteries and user-defined.
18	Equalized charging time	[18] 120 default	5min~900min setting range at 5min step. Valid when battery type is flooded lead-acid batteries and sealed lead-acid batteries.

19	Equalized charging delay	[19] 240 default	5min~900min setting range at 5min step. Valid when battery type is flooded lead-acid batteries, sealed lead-acid batteries and user-defined.
20	Equalized charging interval	[20] 30 default	0~30days setting range at 1-day step. Valid when battery type is flooded lead-acid batteries, sealed lead-acid batteries and user-defined.
21	Equalized charging enable	[21] ENA	Start equalized charging immediately.
		[21] DIS default	Stop equalized charging immediately.
22	Energy-saving mode	[22] DIS default	Disable energy-saving mode.
		[22] ENA	After the power saving mode is enabled, if the load is null or less than 50W, the inverter output is turned off after a delay for a certain period of time. When the load is more than 50W, the inverter automatic restart.
23	Automatic restart after overload	[23] DIS	When the automatic restart after overload is disabled, if the output is turned off upon overload, the machine shall not restore.
		[23] ENA default	When the automatic restart after overload is enabled, if the output shut down, output is restarted by the mains after 3min delay. The machine shall not restarted after 5 times of restarts.
24	Automatic restart after over-temperature	[24] DIS	When automatic restart after over-temperature is disabled, if over-temperature occurs to switch off the output, the machine will no longer switch on the output.

		[24] ENA default	When automatic restart after over-temperature is enabled, If an over-temperature occurs to turn off the output, it will restart to turn on the output when the temperature drops.
25	Buzzer alarm	[25] DIS	Disable alarm.
		[25] ENA default	Enable alarm.
26	Mode change alert	[26] DIS	Disable alarm, when the state of the main input source changes.
		[26] ENA default	Enable alarm, when the state of the main input source changes.
27	Inverter overload to bypass	[27] DIS	Disable automatic switching to mains when inverter is overloaded.
		[27] ENA default	Enable automatic switching to mains when inverter is overloaded.
28	Maximum AC charging current	[28] 60A default	Maximum AC charging current setting. Setting range 0~60A, default 60A.
30	Communication address setting	[30] 1 default	Parallel mode needs to be set, the setting range is 1-6, and cannot be set in parallel operation. Note: Parallel mode can assign address automatically, usually no need to set manually.

32	RS485 communication	[32] SLA default	RS485 port for PC and remote monitoring protocol.
		[32] BMS	RS485 port for BMS communication.
		[32] CAN	CAN port for CAN communication.
33	BMS communication protocols	When [32] setting item = BMS, you need to select the corresponding lithium battery manufacturer's brand for communication.	
		PAC=PACE, RDA=RITAR, AOG=ALLGRAND, OLT=OLITER, HWD=SUNWODA, DAQ=DYNESS, WOW=SRNE, PYL=PYLONTECH, UOL=VILION	
35	Low-voltage disconnect battery voltage recovery point (fault 04)	[35] 13V default	When the battery low voltage disconnects the inverter output, the battery voltage needs to be greater than this setting to restore the battery inverter AC output.
36	Maximum PV charging current	[36] 60A default	Maximum PV charging current setting: 0~60A.
37	Battery fully charged recovery point	[37] 13V default	After the battery is fully charged, it needs to be lower than this set voltage before it can be recharged.
38	AC output voltage setting	[38] 230Vac default	S models: allow to set to 200/208/220/230/240Vac, default 230Vac. AC output power = (Rated Power)*(Setting voltage/230)

39	Charging current limiting method	[39] BMS default	<p>This mode only takes effect when the inverter communicates successfully with the lithium battery BMS (Battery Management System), and the following options can be set:</p> <p>[SET] When this option is selected, the inverter charging current adopts the value set in item [07], in which case item [07] can be set to any value from 0 to the maximum charging current.</p> <p>[BMS] When this option is selected, the charging limit current transmitted by BMS and the value set in [07] will be compared, and the smaller value will be taken as the current charging current, in this case, the charging current that can be set in [07] can not be greater than the the charging limit current of BMS.</p> <p>After [INV] is selected, it will compare the inverter internal current limit value with the value set in item [07], and take the smaller of them as the current charging current. At this time, charging current can be set in item [07] can not be greater than the inverter internal current limit value, and the logic for the inverter internal current limit value is:</p> <ol style="list-style-type: none"> 1. When the battery SOC>98%, the charging current is reduced to 1/16 of the rated charging current value of the inverter. 2. When the battery SOC>95%, the charging current is reduced to 1/8 of the rated charging current of the inverter. 3. When the battery SOC>90%, the charging current is reduced to the inverter rated charging current value 1/4. 4. When battery SOC>85%, the charging current is reduced to the inverter rated charging current 1/2.
57	Stop charging current	[57] 2A default	Stop charging when the charging current is less than the set value.
58	Discharging alarm SOC setting	[58] 15% default	SOC alarm when capacity is less than this setting. (Valid when BMS communication is normal)

59	Stop discharging SOC setting	[59] 5% default	Discharge stops when the capacity is less than this setting value. (Valid when BMS communication is normal)
60	Stop charging SOC setting	[60] 100% default	When the capacity is greater than this setting value, charging stops. (Valid when BMS communication is normal)
61	Switching to mains SOC setting	[61] 10% default	When the capacity is less than this setting value, switch to mains power. (Valid when BMS communication is normal)
62	Switch to inverter output SOC setting	[62] 100% default	When the capacity is greater than this setting, switch to inverter output mode. (Valid when BMS communication is normal)
63	Auto PE-N connect enable	DIS	Disable automatic switching of PE-N connections
		ENA	Enable automatic switching of PE-N connections

5. Other Function

5.1 WIFI/RS485 communication function

There are two communication ports, RS485 and WIFI, and two functions:

- ① RS485 port allows RS485 communication with lithium battery BMS.
- ② WIFI port can be connected with our self-developed RS485 to WIFI/GPRS communication module, which can be connected to our reverse control machine, and you can check the operation parameters and status of the reverse control machine through mobile phone APP.
- ③ As shown in the figure:

Pin 1 is 5V power supply, pin 2 is GND, pin 7 is RS485-A, and pin 8 is RS485-B.

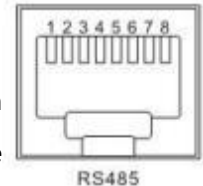

5.2 CAN communication function

Connection to lithium battery communication

The pins are defined as shown:

Pin 4 is CAN-H, Pin 5 is CAN-L

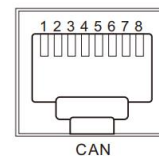

5.3 USB communication function

This port is a USB communication port, which can be used for USB communication with the selected upper computer software of our company (Need to apply for). To use this port, the corresponding "USB to serial port chip CH340T driver" should be installed in the computer.

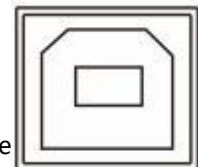

6. Protection

6.1 Protection function

No.	Protection Function	Note
1	PV current/power limiting protection	When the charge current of the configured PV array exceeds the rated current of PV, it will be charged at the rated current.
2	Anti-reverse charge protection at night	At night, because the battery voltage is greater than that of the PV module, the battery shall be protected against discharge through the PV module.
3	AC input over- voltage protection	When the AC voltage exceeds 280V (230V model), the AC charge will be stopped and converted to inverter for output.
4	AC input under- voltage protection	When the AC voltage is lower than 170V (230V model), the AC charge will be stopped and converted to inverter for output.
5	Battery overvoltage protection	When the battery voltage reaches the overvoltage breaking voltage point, charge from PV and AC power to the battery shall be automatically stopped to prevent the battery from being damaged due to overcharge.
6	Battery low- voltage protection	When the battery voltage reaches the low-voltage breaking voltage point, the discharge to the battery will automatically stopped to prevent the battery from damage owing to overdischarge.
7	Load output short circuit protection	In case of short-circuit fault at the load output end, the output of AC voltage can be turned off immediately and then restored 1 minute later. After trying for 3 times, the output load end is still in short circuit state, it is required to eliminate the short circuit fault of the load at first, and then turn on the machine again to restore normal output.
8	Heat sink over temperature protection	In case of excessive internal temperature, the machine shall stop charge and discharge; after the temperature returns to normal state, the machine shall restore charge and discharge.
9	Overload protection	There is output within 3 minutes after overload protection. The output is turned off in case of 5 times of continuous overload until the machine is turned on again. Specific overload grade and duration are shown in the technical parameter table after the manual.
10	AC reverse flowing protection	Prevent AC power inverted from battery inverting against reverse flowing into bypass AC input.

11	Bypass overcurrent protection	Built-in AC input overcurrent protection breaker.
----	-------------------------------	---

6.2 Meaning of fault code

Fault Code	Fault Name	Affecting output or not	Note
【01】	BatVoltLow	Yes	Battery under-voltage alarm
【02】	BatOverCurrSw	Yes	Battery discharge average current over-current software protection
【03】	BatOpen	Yes	Battery not connected alarm
【04】	BatLowEod	Yes	Battery under-voltage stop discharging alarm
【05】	BatOverCurrHw	Yes	Battery over-current hardware protection
【06】	BatOverVolt	Yes	Charge over-voltage protection
【07】	BusOverVoltHw	Yes	Bus over-voltage hardware protection
【08】	BusOverVoltSw	Yes	Bus over-voltage software protection
【09】	PV VoltHigh	No	PV over-voltage protection
【10】	PV OCSw	No	PV over-current software protection
【11】	PV OCHw	No	PV over-current hardware protection
【12】	bLineLoss	No	AC power failure
【13】	OverloadBypass	Yes	Bypass overload protection
【14】	OverloadInverter	Yes	Inverter overload protection
【15】	AcOverCurrHw	Yes	Inverter overcurrent hardware protection
【16】	-	-	-
【17】	InvShort	Yes	Inverter short-circuit protection
【18】	-	-	-
【19】	OverTemperMppt	No	PV heatsink over temperature protection

【20】	OverTemperInv	Yes	Inverter heat sink over-temperature protection
【21】	FanFail	Yes	Fan fault
【22】	EEPROM	Yes	Memory fault
【23】	ModelNumErr	Yes	Inaccurate model setting
【26】	RlyShort	Yes	Inverted AC output backfills to bypass AC input
【29】	BusVoltLow	Yes	Bus under-voltage protection
【30】	BatCapacityLow1	No	Battery capacity below 10% alarm (valid when BMS is enabled)
【31】	BatCapacityLow2	No	Battery capacity below 5% alarm (valid when BMS is enabled)
【32】	BatCapacityLowStop	Yes	Battery low capacity shutdown (valid when BMS is enabled)
【58】	BMS communication fault	NO	Check whether the communication cable is connected correctly and whether item [33] is set to the corresponding lithium battery communication protocol
【60】	BMS battery low-temperature alarm	NO	Li-ion battery BMS low-temperature alarm
【61】	BMS battery over-temperature alarm	NO	Li-ion battery BMS over-temperature alarm
【62】	BMS battery over-current alarm	NO	Li-ion battery BMS over-current alarm
【63】	BMS battery under-voltage alarm	NO	Li-ion battery BMS under-voltage alarm
【64】	BMS battery over-voltage alarm	NO	Li-ion battery BMS over-voltage alarm

6.3 Some fault troubleshooting

Fault	Solving Measures
No display on screen	Check whether the battery air switch or PV air switch is closed; whether the switch is in "on" state; press any key on the screen to exit from the screen sleep mode.
Charge battery overvoltage protection	Measure whether the battery voltage exceeds 15.5V, and disconnect the PV array air switch and the AC air switch.
Battery undervoltage protection	After the battery charge restores to be above low-voltage disconnection recovery voltage.
Fan fault	Check if the fan doesn't work or if it's blocked by something else.
Radiator over temperature protection	When the device cools below the overtemperature recovery temperature, it shall restore to normal charge and discharge control.
Bypass overload protection, inverting overload protection	1.Decrease consumer; 2.Restart machine and the load output is restored.
Inverting short-circuit protection	1.Carefully check load connection condition, clear short-circuit fault point; 2.After power on again, the load output is restored.
PV over-voltage	Check whether PV input voltage exceeds maximum allowable input voltage with a multimeter.
No connection alarm of battery	Check whether the battery is not disconnected or whether the breaker at the battery side is not closed.

7. System Maintenance

- **In order to maintain the best long-term performance, it is recommended to conduct following checks twice a year.**
- 1. Confirm that the air flow around the machine will not be blocked. In addition, remove any dirt or debris from the radiator.
- 2. Check whether the insulation of all exposed wires is damaged due to sun exposure, friction with other objects around, dry rot, insect or rat damage, etc. If necessary, it is required to repair or replace the wires.
- 3. Verify that the indication and display are consistent with the operation of the device. Please pay attention to any fault or error display and take corrective measures if necessary.
- 4. Check all terminals for corrosion, insulation damage, high temperature or burning/discoloration sign, and tighten the terminal screws.
- 5. Check for dirt, nesting insects and corrosion phenomenon and clean as required.
- 6. If the arrester has failed, replace the failed arrester in time to protect the machine and other user device against lightning damage.

Warning: Danger of electric shock! To perform above operations, make sure that all the power supplies of the machine have been broken and all the capacitor electricity has been discharged. Afterwards, corresponding inspection or operation can be performed!

- **We are not responsible for any following damage:**
- ① Damage caused by improper use or use in inappropriate place.
- ② Open-circuit voltage of PV module exceeds maximum allowable voltage.
- ③ The damage caused by the operation ambient temperature beyond the limited operation temperature range.
- ④ Personally take apart and maintain the machine.
- ⑤ Damage caused by force majeure: damage caused by transportation and handling of the machine.

8. Technical Parameter

Model	HF1210S60-108	HF1215S60-108
AC mode		
Rated input voltage	220/230Vac	
Input voltage range	(170Vac~280Vac) $\pm 2\%$ (90Vac-280Vac) $\pm 2\%$	
Frequency	50Hz/ 60Hz (auto-detect)	
Frequency range	47 ± 0.3 Hz ~ 55 ± 0.3 Hz (50Hz); 57 ± 0.3 Hz ~ 65 ± 0.3 Hz (60Hz);	
Efficiency	>92%	
Conversion time	10ms (Typical value)	
(Bypass and inverting)		
AC reverse flowing protection	yes	
Maximum bypass overload current	6.5A	9.7A
Inverting mode		
Output voltage waveform	Pure sine wave	
Rated output power (VA)	1000	1500
Rated output power (W)	1000	1500
Power factor	1	
Rated output voltage (Vac)	230Vac(200/208/220/240Vac Settable)	
Output voltage error	$\pm 5\%$	
Output frequency range (Hz)	50Hz ± 0.3 Hz/60Hz ± 0.3 Hz	
Efficiency	>92%	
Overload protection	(102%<load<110%): Alarm and shutdown after 5 minutes. (110%<load<125%): Alarm and shutdown after 10 seconds. Load>125%: Alarm and shutdown after 5 seconds.	
Peak power	2000VA	3000VA
Loaded motor capacity	1HP	
Rated battery input voltage	12V	
Battery voltage range	10.5Vdc~15.5Vdc (undervoltage alarm/turnoff voltage/overvoltage alarm/overvoltage restoration...settable LCD screen)	
Power saving mode	Load ≤ 50 W	
AC charging		

Battery type	Lead acid or lithium battery
Maximum charge current	60A
Charge current error	± 5A _{dc}
Charge voltage range	10.5–15.5V _{dc}
Short-circuit protection	Breaker and blown fuse
Overcharge protection	Alarm, stop charging after 1 minute
PV charging	
Max. PV open-circuit voltage	108V _{dc}
MPPT voltage range	15-90V _{dc}
Battery voltage range	10.5–15.5V _{dc}
Maximum input power	1000W
Charge current range of solar energy (settable)	0~60A
Charge short-circuit protection	Blown fuse
Wiring protection	Inverse wiring protection
Max. hybrid charging current (PV+AC)	0~120A
Certified specifications	
Certification	CE(IEC 62109-1/62109-2)
EMC authentication grade	EN61000, C2
Operation temperature range	-10°C to 55°C
Humidity range	5% to 95% (three-proof paint protection)
Noise	≤60dB
Thermal dissipation	Forced cooling with adjustable air speed
Communication interface	USB/RS485 (WiFi/GPRS)
Dimension (L*W*D)	357.5*235*103mm
Weight (kg)	5.5